

Pneumatically Actuated Wafer Style Butterfly Valve Type 240



General

- **Size:** 2"–12"
- **Outer Body:** Glass-filled PP
- **Material:** PVC, CPVC, PROGEF® Standard PP, ABS, SYGEF® Standard PVDF
- **Seals:** EPDM, FPM, PTFE/FPM
- **Stem:** 316 stainless steel
- **Hardware:** 304 stainless steel
- **Actuator Housing:** Anodized Aluminum
- **Action:** FO,FC,DA
- **Connection:** Both ANSI 150 and DIN 2501
- **Stroke Limiter:** 10 degrees open/close
- **Standard Pack Quantity:** 1 valve

Sample Specification

The Type 240 Pneumatically Actuated Butterfly Valve shall be wafer style compatible with both ANSI B16.5 150 lb and DIN 2501 flange patterns. The disk operation shall utilize double eccentric design principles. The shaft shall be non-wetted by a bushing assembly with double O-ring seals and fixed at both ends. The face seal shall be a Q-ring compatible with flat and serrated flange adapters. The face, disk and shaft seals shall operate independently. The wetted body and disk shall be of like materials. Valves shall be rated for bidirectional use. The actuator housing material shall be anodized aluminum. The pneumatic connections and accessory console mounting pattern shall be NAMUR compliant. The end stops shall be mechanically adjustable by 10 degrees in the open and close positions. All valves shall be tested in accordance to ISO9393 and designed to ISO16136 standards. All valves shall be manufactured under ISO9001 for Quality and ISO14001 for Environmental Management. Following assembly, every valve shall be tested and certified bubble tight exceeding Class VI standards.

Material Specification

PVC valves shall meet ASTM D1784 cell classification 12454 standards. CPVC valves shall meet ASTM D1784 cell classification 23447-B standards. PP valves shall meet ASTM D5847-14 cell classification PP0510B66851 standards. ABS valves shall meet ASTM D3965 cell classification 42222 standards. PVDF valves shall be type 1, grade 2 according to ASTM D3222 standards. Valves of all materials shall be RoHS compliant.

Key Valve Certifications

- **NSF 61:** PVC and CPVC
- **FDA CFR 21 177.1520:** PP and PVDF
- **FDA CFR 21 177.2600:** EPDM and FPM
- **FDA CFR 21 177.1550:** PTFE
- **ABS:** All materials
- **USP Class VI (physiological non-toxic):** EPDM, FPM, PTFE, PP and PVDF

Key Design Feature

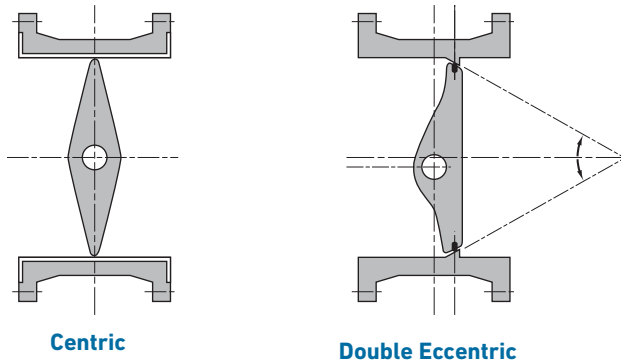

Components

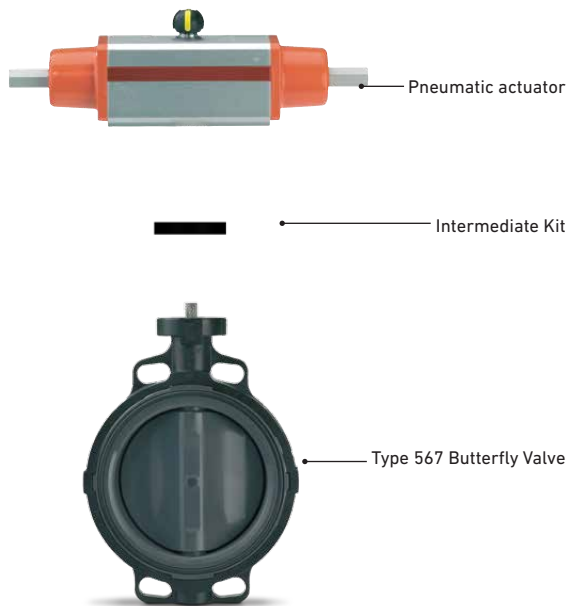

Optional Features

- **Pilot Valve:** 24VAC/DC, 110VAC, 230VAC
- **Positioner:** Digital electro-pneumatic
- **Limit Switches:** Mechanical, inductive
- **Manual Loading Station:** Local control box
- **Manual Override:** Stainless steel
- **Stem Extension:** Two piece stainless steel
- **Shaft:** Titanium, Hastelloy-C
- **Hardware:** Alternatives available upon request
- **Cleaned:** Silicone free/oil free

Material Availability

It is not possible to use inner housings with disks of different material. Valves of all sizes and materials are available with both EPDM and FPM seals. Only CPVC, PP and PVDF valves are available with PTFE encapsulated FPM disc seals. GF does not offer disc seals that deviate from their standard product offering.

Double Eccentric Design Principle

The Type 240 PA Butterfly Valve is designed using the double eccentric disc principle. When opening and closing, the disc is not in contact with the seat, significantly reducing component wear. This design principle greatly reduces the operating torque and required elastomeric sealing material. The reduction in sealing material decreases the impact of elastomeric swelling. The benefits of double eccentric valves include a reduction in required actuator torque and extended valve lifetime.



Key Design Features



Type 567: Type 240 Base Valve

Seals

The Type 240 Butterfly Valve features a truly non-wetted shaft design. The shaft is sealed with a bushing assembly on either side of the disc. Each bushing utilizes a double o-ring seal totalling eight shaft seals in every valve.

Alternative o-ring shaft sealing designs are commonly found in competitive boot style thermoplastic butterfly valves. However, these solutions often rely upon elastomer on elastomer seals which can be unreliable, especially in chemical process applications or when working temperatures deviate from standard conditions. The Type 240 shaft seal design eliminates the need elastomer on elastomer seals, providing an industry tested dynamic double o-ring seal against a ridged thermoplastic surface.



The shaft, disc and face seals all operate independently from one another. This eliminates issues common to booted style centric valves such as crimping, where the compression of the valve between two flanges causes the boot to ripple. This can lead to increased operating torque and wear, ultimately reducing the useful life of the valve.

Actuator Technical Data

	PA 30-70
Control Medium	Neutral, non aggressive gases (max. 104°F)
Actuator Style	Scotch yoke
Max Allowable Control Pressure	100 psi
Pneumatic Connection	1/8" BSP (2"-8" FC/FO) 1/4" BSP (10" and 12" FC/FO) 1/8" BSP (2"-12" DA) NPT adapter included with assembled valves
Cycle Time/90°	1-2 seconds
Operating Temperature	14°F-176°F
Actuation Angle	90°
Action	Fail-safe close (FC) Fail-safe open (FO) Double acting (DA)
Permissible Humidity	0-95%
Position Indicator	Visual
Housing Material	Anodized aluminium

Technical Data

Pressure-Temperature Curves

The following graphs are based on a lifetime of 25 years of water or similar media applications

PVC

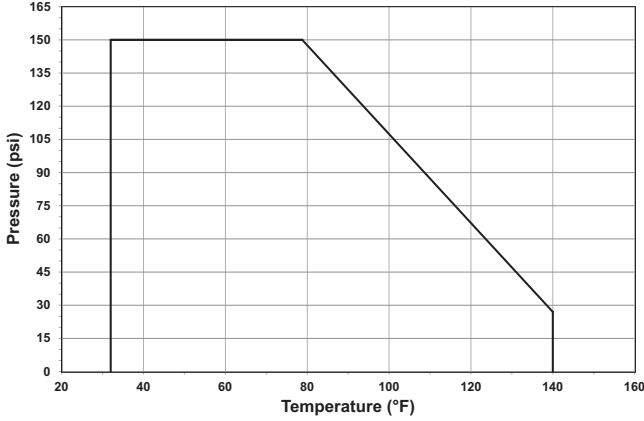

CPVC

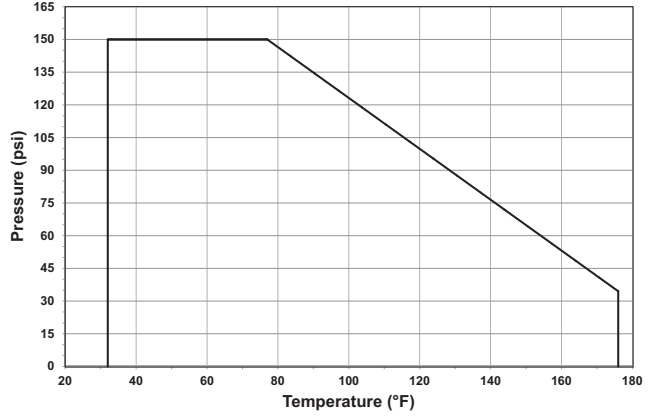

PP

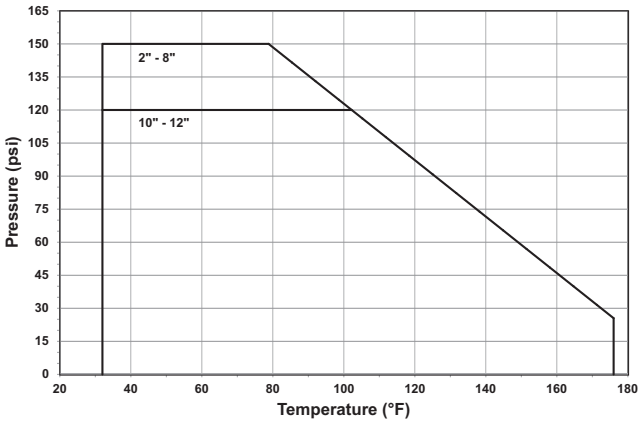

ABS

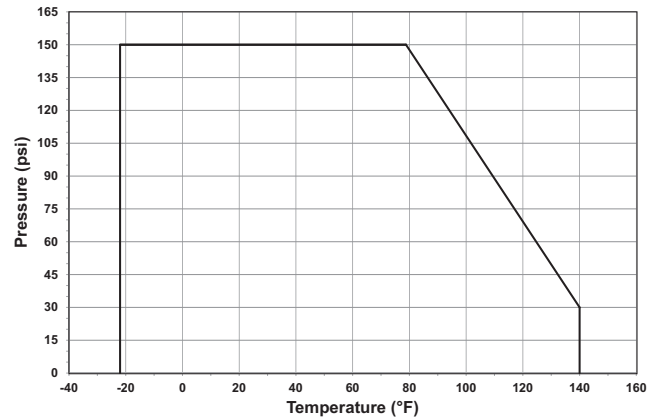

PVDF

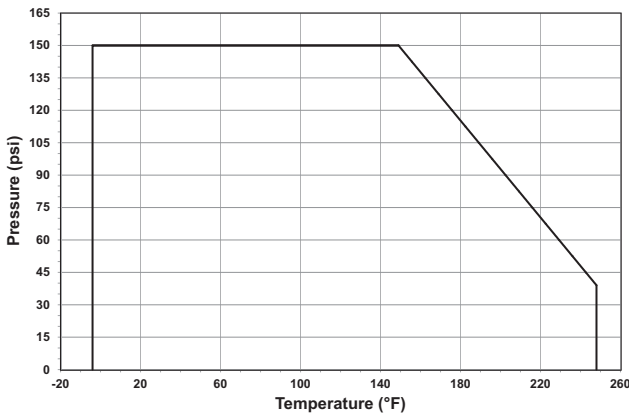

Pressure-Temperature

Material	Temperature Range (°F)	Max Pressure (psi)
PVC	32 to 140	150
CPVC	32 to 176	150
PP	32 to 176	150*
ABS	-40 to 140	150
PVDF	-4 to 284	150

*Dependant on size as shown in P-T curves

Vacuum Service

The Type 240 is rated for full vacuum service. Maximum differential pressure of 15psi at 122°F.

Flow

The following information is based on water applications at 68° F

Flow Characteristics

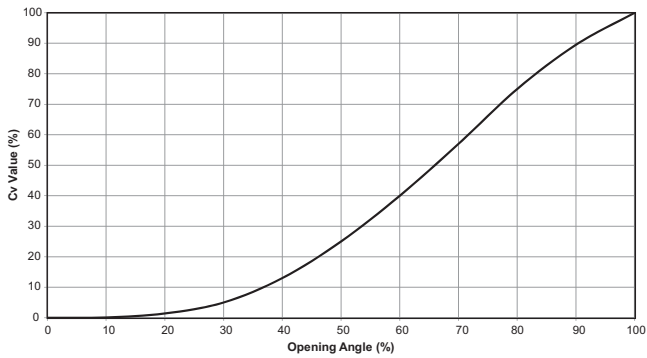

Cv Value

Size (inch)	d (mm)	Cv (gal/min)
2	63	103
2½	75	154
3	90	210
4	110	455
5	140	805
6	160	1162
8	225	2772
10	280	3570
12	315	5110

Dimensions

The following tables are shown in millimeters unless otherwise specified

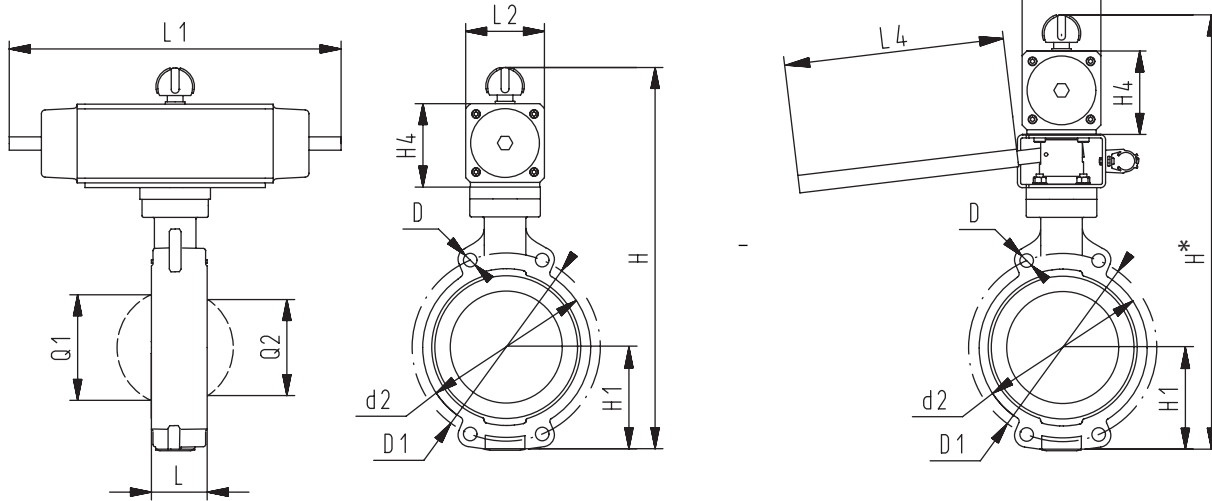

All Materials

**Optional Manual Override
All Materials 2”–8” (d63–d225)**

All Materials

Size (inch)	d (mm)	d2	D	D1 min	D1 max	H	H*	H1	H4	L	L1	L2	L4	Q1	Q2
2	63	104	19	120	125	328	388	77	70	45	276	65	200	40	-
2½	75	115	19	140	145	340	400	83	70	46	276	65	200	54	35
3	90	131	19	150	160	361	421	89	78	49	326	72	200	67	50
4	110	161	19	175	191	402	462	104	86	56	370	80	250	88	74
5	140	187	23	210	216	441	501	117	96	64	411	90	250	113	97
6	160	215	24	241	241	471	531	130	106	72	423	100	250	139	123
8	225	267	23	290	295	530	590	158	118	73	452	112	250	178	169
10	280	329	25	353	362	660	-	205	148	113	648	137	-	210	207
12	315	379	25	400	432	715	-	228	157	113	663	145	-	256	253

H* including optional manual override

Dimensions

The following tables are shown in millimeters unless otherwise specified

Pneumatic Connection Detail

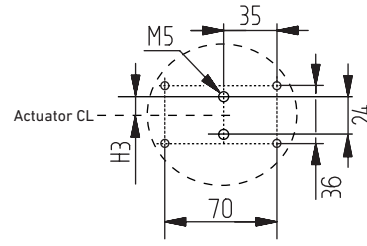
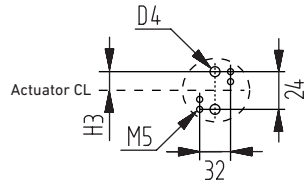

Actuator Front

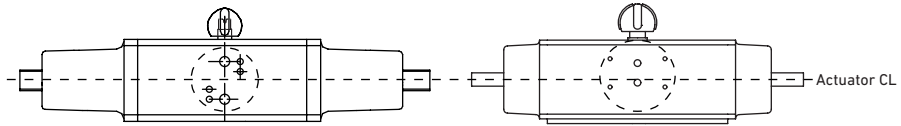

Actuator Top

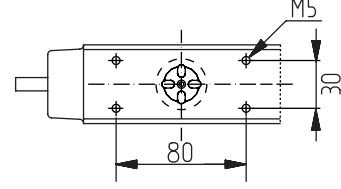
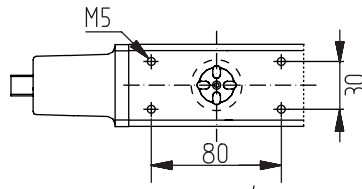

Position Indicator Top

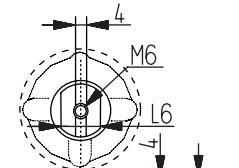
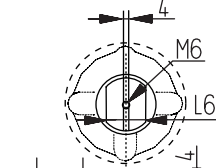

Position Indicator Front

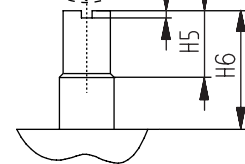
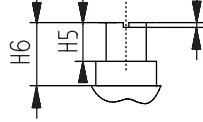

FC/FO: 10"/12" (d280/d315)
DA: 12" (d315)

All Other Configurations

All Materials

Size (inch)	d (mm)	Size	Action	D4	H3	H5	H6	L6
2	63	PA30	FC/FO	G $\frac{1}{8}$ "	17.9	13	20	10
2½	75	PA30	FC/FO	G $\frac{1}{8}$ "	17.9	13	20	10
3	90	PA35	FC/FO	G $\frac{1}{8}$ "	17.9	13	20	12
4	110	PA40	FC/FO	G $\frac{1}{8}$ "	21	13	30	12
5	140	PA45	FC/FO	G $\frac{1}{8}$ "	21	16	30	15
6	160	PA50	FC/FO	G $\frac{1}{8}$ "	21	17	30	15
8	225	PA55	FC/FO	G $\frac{1}{8}$ "	25	19	30	19
10	280	PA65	FC	G $\frac{1}{4}$ "	34	19.5	30	22
10	280	PA70	FO	G $\frac{1}{4}$ "	38	19.5	30	24
12	315	PA70	FC/FO	G $\frac{1}{4}$ "	43	19.5	30	24
2	63	PA35	DA	G $\frac{1}{8}$ "	12.5	13	20	10
2½	75	PA35	DA	G $\frac{1}{8}$ "	12.5	13	20	10
3	90	PA40	DA	G $\frac{1}{8}$ "	17.9	13	20	10
4	110	PA45	DA	G $\frac{1}{8}$ "	17.9	13	20	12
5	140	PA45	DA	G $\frac{1}{8}$ "	17.9	13	20	12
6	160	PA55	DA	G $\frac{1}{8}$ "	21	16	30	15
8	225	PA55	DA	G $\frac{1}{8}$ "	21	16	30	15
10	280	PA65	DA	G $\frac{1}{8}$ "	25	19	30	19
12	315	PA70	DA	G $\frac{1}{4}$ "	26	19	30	19