

Section 8

# Fuseal<sup>®</sup> Corrosive Waste Piping System



## Glossary

S	= Fuseal Electrofusion Socket
SPG	= Spigot End (same dimension as pipe outside diameter)
FT	= Female Thread (Straight)
MT	= Male Thread (Straight)
MPT	= Male Pipe Thread
FPT	= Female Pipe Thread
MJ	= Mechanical Joint Socket
PPFR	= Polypropylene Flame Retardant
PPNFR	= Polypropylene Non-Flame Retardant

Product Line	Description	Discount
07	Fusion Accessories	_____
22	PPNFR Sch. 40 pipe	_____
23	PPFR Sch. 40 pipe	_____
28	PPNFR Sch. 80 pipe	_____
30	Neutralization Tanks and Accessories	_____
21	PPNFR Fusion Fittings-Fab	_____
51	PPFR Fusion Fittings-Fab	_____
52	PPFR Fusion Fittings-Molded	_____
53	PPFR MJ Fittings	_____

The technical information given in this publication implies no warranty of any kind and is subject to change without notice. Please consult our Terms and Conditions of Sale.

### Not for Use with Compressed Air or Gases

#### DO NOT TEST with Air or Air over Water

GF Piping Systems DOES NOT RECOMMEND the use of thermoplastic piping products for systems to transport or store compressed air or gases, or the testing of thermoplastic piping systems with compressed air or gases in above or below ground locations. The use of GF Piping products in compressed air or gas systems automatically voids the warranty for such products, and their use against our recommendation is entirely the responsibility and liability of the installer. GF will not accept responsibility for damage or impairment from its products, or other consequential or incidental damages caused by misapplication, incorrect assembly, and/or exposure to harmful substances or conditions.

**For more information about any of our product lines, please call (800) 423-2686.**



Fuseal PPFR & PPNFR Pipe

8



Fuseal Fusion Fittings PPFR

10



Fuseal Cleanouts & Floor Drains PPFR

27



Fuseal Traps PPFR

31



Fuseal LD Fusion Fittings PP

38



Fuseal Fusion Accessories

43



Fuseal Mechanical Joint Fittings PPFR

45



Neutralization and Dilution Tanks

52



pH Monitoring Systems

54

# Fuseal PPFR & PPNFR Pipe

A

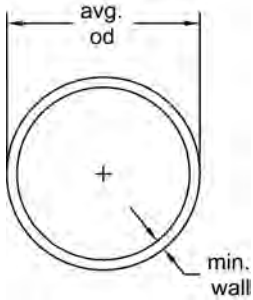

## Schedule 40 PPFR

1 1/2" - 6" Available in 20' lengths upon request

Size (inch)	lengths (ft)	Part No.	Lift Qty (ft)	avg. od (inch)	min. wall (inch)
1 1/2	10	* 37A013015	1800	1.900	0.145
2	10	* 37A013020	1050	2.375	0.154
3	10	* 37A013030	580	3.500	0.216
4	10	* 37A013040	510	4.500	0.237
6	10	* 37A013060	220	6.625	0.280
8	20	* 37A023080	280	8.625	0.322
10	20	* 37A023100	220	10.750	0.365
12	20	* 37A023120	100	12.750	0.406

A

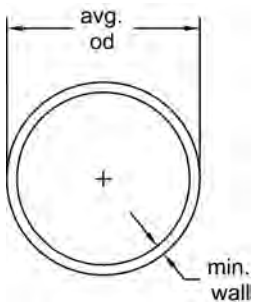

## Schedule 40 PPNFR

Size (inch)	lengths (ft)	Part No.	Lift Qty (ft)	avg. od (inch)	min. wall (inch)
1 1/2	20	* 37B023015	3600	1.900	0.145
2	20	* 37B023020	2100	2.375	0.154
3	20	* 37B023030	1160	3.500	0.216
4	20	* 37B023040	1020	4.500	0.237
6	20	* 37B023060	440	6.625	0.280
8	20	* 37B023080	280	8.625	0.322
10	20	* 37B023100	220	10.750	0.365
12	20	* 37B023120	100	12.750	0.406
14	20	* 37B023140	100	14.000	0.437
16	20	* 37B023160	100	16.000	0.500
18	20	* 37B023180	60	18.000	0.562

A



**Schedule 80 PPNFR**

Size (inch)	lengths (ft)	Part No.	USD	Lift Qty (ft)	avg. od (inch)	min. wall (inch)
1 ½	20	* 37B021015		3600	1.900	0.200
2	20	* 37B021020		2100	2.375	0.281
3	20	* 37B021030		1160	3.500	0.300
4	20	* 37B021040		1020	4.500	0.337
6	20	* 37B021060		440	6.625	0.432
8	20	* 37B021080		280	8.625	0.500
10	20	* 37B021100		220	10.750	0.593
12	20	* 37B021120		100	12.750	0.687

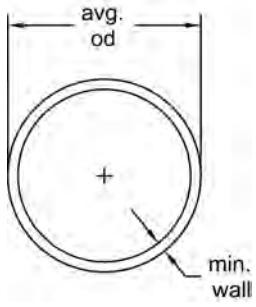

# Fuseal Fusion Fittings PPR

A



## Coupling (S x S)

Size (inch)	Part No.	L	N (inch)
1 ½	527001		0.06
2	527002		0.06
3	527003		0.13
4	527004		0.13
6	527006		0.19

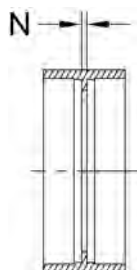

A



## Sleeve Coupling (S x S)

Size (inch)	Part No.	USD	L (inch)
1 ½	527041		1.56
2	527042		1.81
3	527043		2.00
4	527044		2.00
6	527046		2.69



A



## 1/4 Bend (91.2°) - Long Sweep (S x S)

Size (inch)	Part No.	USD	G (inch)
1 ½	526276		2.75
2	526277		3.25
3	526278		4.06
4	526279		4.94
6	* 526280F		11.00

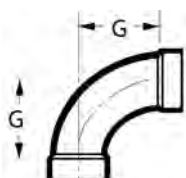

A

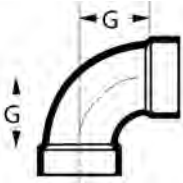
**1/4 Bend (91.2°) - Short Sweep (S x S)**

Size (inch)	Part No.	USD	G (inch)
1 1/2	526251	27.36	1.75
2	526252	53.26	2.31
3	526253	57.62	3.06
4	526254	93.58	3.88
6	526256	223.83	5.63

A

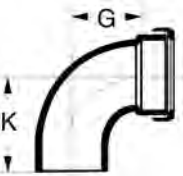
**1/4 Bend (91.2°) - Street (S x SPG)**

Size (inch)	Part No.	USD	G (inch)	K (inch)
1 1/2	526451	32.44	1.75	3.11
2	526452	41.76	2.31	3.70
3	526453	53.26	3.06	4.75
4	526454	90.67	3.88	5.38
6	*526456F	484.97	11.00	10.81

A

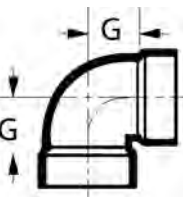
**1/4 Bend (90°) - Vent (S x S)**

Size (inch)	Part No.	USD	G (inch)
1 1/2	526201	38.86	1.19
2	526202	43.21	1.50
3	526203	64.77	1.88

A

**1/6 Bend (60°) (S x S)**

Size (inch)	Part No.	USD	J (inch)
1 1/2	526601	54.72	1.00
2	526602	61.87	1.31
3	526603	67.67	1.69
4	526604	97.82	2.06

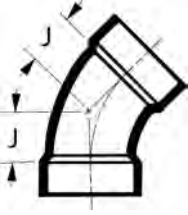

A

**1/8 Bend (45°) (S x S)**

Size (inch)	Part No.	USD	J (inch)
1 1/2	526501	25.91	1.13
2	526502	33.16	1.50
3	526503	60.41	1.75
4	526504	67.67	2.19
6	526506	187.56	3.37



A

**1/8 Bend (45°) - Street (S x SPG)**

Size (inch)	Part No.	USD	J (inch)	K (inch)
1 1/2	526401	20.93	1.13	2.44
2	526402	22.38	1.50	2.50
3	526403	48.19	1.75	3.25
4	526404	56.17	2.19	3.25
6	526406	153.37	3.38	4.75

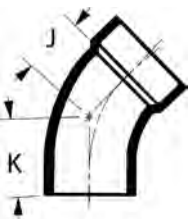



A

**1/12 Bend (30°) (S x S)**

Size (inch)	Part No.	USD	J (inch)
1 ½	526951	48.91	0.75
2	526952	54.72	0.88
3	526953	60.41	1.25
4	526954	87.77	1.50

A

**1/12 Bend (30°) - Street (S x SPG)**

Size (inch)	Part No.	USD	J (inch)	K (inch)
1 ½	526461	45.08	0.75	1.88
2	526462	50.36	0.88	2.26
3	526463	55.65	1.25	2.56
4	526464	80.73	1.50	2.81

A

**1/16 Bend (22.5°) (S x S)**

Size (inch)	Part No.	USD	J (inch)
1 ½	526551	25.91	0.50
2	526552	36.06	0.69
3	526553	67.67	0.81
4	526554	77.72	1.00
6	* 526556F	Call	6.25

A

**1/24 Bend (15°) (S x S)**

Size (inch)	Part No.	USD	J (inch)
1 ½	526971	45.08	0.62
2	526972	50.36	0.63
3	526973	55.65	0.81
4	526974	80.73	0.87

A

**1/24 Bend (15°) - Street (S x SPG)**

Size (inch)	Part No.	USD	J (inch)	K (inch)
1 1/2	526961	45.08	0.62	1.51
2	526962	50.36	0.63	1.75
3	526963	55.65	0.81	2.12
4	526964	80.73	0.88	2.18

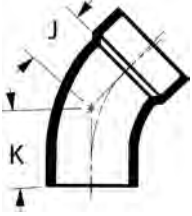

A

**3-Way Ell (91.2°) (S x S x S)**

Size (inch)	Part No.	USD	G (inch)
1 1/2	526261	63.32	1.75
2	526262	90.67	2.31

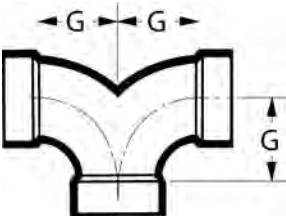

A

**45° Wye (S x S x S)**

Size (inch)	Part No.	USD	GJ (inch)	GN (inch)	N (inch)
1 1/2	526301	37.41	2.88	1.13	4.00
2	526302	51.81	3.63	1.38	5.00
3	526303	86.32	5.00	1.63	6.63
4	526304	125.39	6.38	1.88	8.25
6	526306	324.35	9.13	1.63	10.75

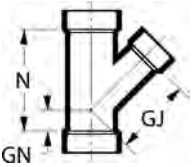

A

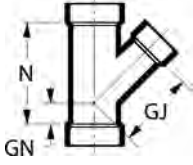
**45° Wye - Reducing (S x S x S)**

Size (inch)	Part No.	USD	GJ (inch)	GN (inch)	N (inch)
2 x 2 x 1 1/2	<b>526325</b>	<b>48.91</b>	3.44	1.06	4.38
3 x 3 x 1 1/2	<b>526324</b>	<b>90.67</b>	6.25	0.88	5.00
3 x 3 x 2	<b>526326</b>	<b>97.82</b>	4.63	0.88	5.00
4 x 4 x 2	<b>526328</b>	<b>116.06</b>	5.56	0.38	5.06
4 x 4 x 3	<b>526327</b>	<b>122.28</b>	6.00	1.06	6.63
6 x 6 x 2	<b>526342</b>	<b>195.85</b>	6.75	-1.13	4.73
6 x 6 x 3	<b>526343</b>	<b>216.58</b>	7.43	0.19	6.38
6 x 6 x 4	<b>526344</b>	<b>224.87</b>	7.75	0.68	7.73

A

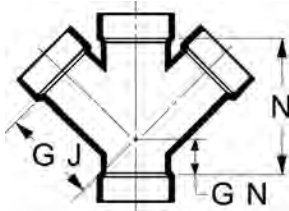
**45° Wye - Double (S x S x S x S)**

Size (inch)	Part No.	USD	GJ (inch)	GN (inch)	N (inch)
1 1/2	<b>526380</b>	<b>63.32</b>	3.50	1.13	4.63
2	<b>526381</b>	<b>90.67</b>	4.00	1.38	5.38
3	<b>526382</b>	<b>125.39</b>	5.00	1.63	7.63
4	<b>526383</b>	<b>195.85</b>	6.38	1.88	9.25
6	<b>* 526351F</b>	<b>964.77</b>	12.18	6.18	18.38

A

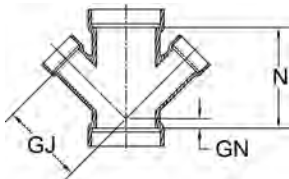
**45° Wye - Double Reducing (S x S x S x S)**

Size (inch)	Part No.	USD	GJ (inch)	GN (inch)	N (inch)
2 x 2 x 1 1/2 x 1 1/2	<b>526384</b>	<b>86.32</b>	3.44	1.06	5.38
3 x 3 x 1 1/2 x 1 1/2	<b>526389</b>	<b>134.72</b>	4.31	0.50	5.25
3 x 3 x 2 x 2	<b>526385</b>	<b>144.04</b>	4.63	0.88	6.00
4 x 4 x 2 x 2	<b>526386</b>	<b>231.09</b>	5.56	0.38	6.06
4 x 4 x 3 x 3	<b>526387</b>	<b>231.09</b>	6.00	1.06	7.63
6 x 6 x 3 x 3	<b>* 526390T</b>	<b>1,144.04</b>	9.94	1.75	12.38
6 x 6 x 4 x 4	<b>* 526388T</b>	<b>1,144.04</b>	10.13	2.25	12.38

A



### Long Turn Tee Wye (91.2°) (S x S x S)

Size (inch)	Part No.	USD	G (inch)	N (inch)
1 1/2	<b>527301</b>	<b>45.39</b>	3.94	3.63
2	<b>527302</b>	<b>57.62</b>	5.13	4.44
3	<b>527303</b>	<b>97.82</b>	7.56	6.50
4	<b>527304</b>	<b>134.72</b>	9.82	8.75

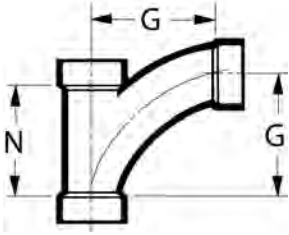

A



### Long Turn Tee Wye (91.2°) - Reducing (S x S x S)

Size (inch)	Part No.	USD	GJ (inch)	GK (inch)	N (inch)
2 x 2 x 1 1/2	<b>527320</b>	<b>54.72</b>	3.94	4.19	3.63
3 x 3 x 1 1/2	<b>527326</b>	<b>82.07</b>	3.94	4.75	3.81
3 x 3 x 2	<b>527327</b>	<b>86.32</b>	5.13	5.69	4.75
4 x 4 x 2	<b>527337</b>	<b>122.28</b>	5.13	6.13	4.50
4 x 4 x 3	<b>527338</b>	<b>127.46</b>	7.56	8.06	6.50

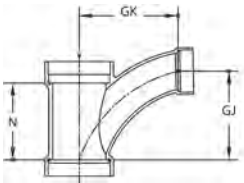

A



### Combo Wye & 1/8 Bend (90°) (S x S x S)

Size (inch)	Part No.	USD	GJ (inch)	GK (inch)	N (inch)
6	<b>* 527306F</b>	<b>461.14</b>	11.41	13.18	10.75

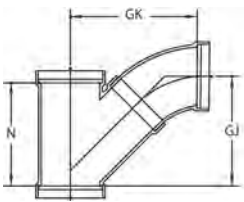

A

**Combo Wye & 1/8 Bend (90°) - Reducing (S x S x S)**



Size (inch)	Part No.	USD	GJ (inch)	GK (inch)	N (inch)
6 x 6 x 2	* 527344F	446.63	5.44	8.06	4.73
6 x 6 x 3	* 527339F	446.63	7.00	9.19	6.38
6 x 6 x 4	* 527340F	470.47	8.44	9.94	7.73

A

**Combo Wye (90°) - Double (S x S x S x S)**

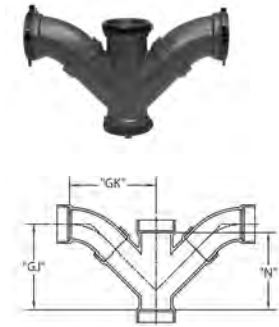

Size (inch)	Part No.	USD	GJ (inch)	GK (inch)	N (inch)
1 1/2	526801	96.48	5.31	5.31	4.63
2	526802	121.24	5.98	6.10	5.38
3	526803	144.04	7.47	7.59	7.63
4	526804	240.41	8.69	9.00	9.25
6	* 526806F	1,240.41	18.18	15.44	18.38

A

**Combo Wye (90°) - Double Reducing (S x S x S x S)**



Size (inch)	Part No.	USD	GJ (inch)	GK (inch)	N (inch)
2 x 2 x 1 1/2 x 1 1/2	526825	112.95	5.22	5.27	5.38
3 x 3 x 1 1/2 x 1 1/2	526824	168.91	5.27	5.89	5.25
3 x 3 x 2 x 2	526826	180.31	5.91	6.54	6.00
4 x 4 x 2 x 2	526828	313.99	6.08	7.20	6.06
4 x 4 x 3 x 3	526827	313.99	7.61	8.29	7.63
6 x 6 x 3 x 3	* 526843T	1,481.87	11.18	11.18	12.38
6 x 6 x 4 x 4	* 526844T	1,481.87	11.81	11.75	12.38

A

**Sanitary Tee (91.2°) (S x S x S)**



Size (inch)	Part No.	USD	G (inch)	N (inch)
1 1/2	526151	34.61	1.75	2.75
2	526152	40.31	2.31	3.69
3	526153	80.62	3.06	4.88
4	526154	121.24	3.88	6.13
6	* 526156F	806.22	14.25	18.38

A

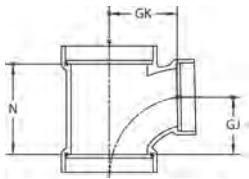

### Sanitary Tee (91.2°) - Reducing (S x S x S)

Size (inch)	Part No.	USD	GJ (inch)	GK (inch)	N (inch)
2 x 2 x 1 1/2	<b>526126</b>	<b>40.31</b>	1.96	2.21	3.17
3 x 3 x 1 1/2	<b>526131</b>	<b>72.02</b>	1.75	2.56	2.68
3 x 3 x 2	<b>526130</b>	<b>80.62</b>	2.13	2.88	3.31
4 x 4 x 2	<b>526134</b>	<b>108.81</b>	2.06	3.31	3.19
4 x 4 x 3	<b>526136</b>	<b>118.13</b>	3.00	3.56	4.75
6 x 6 x 2	* <b>526137F</b>	<b>374.09</b>	3.93	6.00	6.13
6 x 6 x 3	* <b>526138F</b>	<b>374.09</b>	3.93	6.40	6.13
6 x 6 x 4	<b>526139</b>	<b>395.85</b>	3.93	4.90	6.13

A

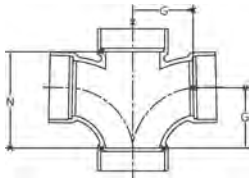

### Sanitary Tee (91.2°) - Double (S x S x S x S)

Size (inch)	Part No.	USD	G (inch)	N (inch)
1 1/2	<b>526187</b>	<b>72.02</b>	1.75	2.75
2	<b>526186</b>	<b>97.82</b>	2.31	3.69
3	<b>526183</b>	<b>127.46</b>	3.06	4.88
4	<b>526185</b>	<b>161.66</b>	3.88	6.13

A

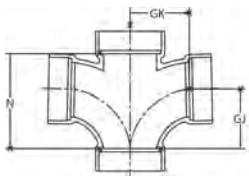

### Sanitary Tee (91.2°) - Double Reducing (S x S x S x S)

Size (inch)	Part No.	USD	GJ (inch)	GK (inch)	N (inch)
2 x 2 x 1 1/2 x 1 1/2	<b>526188</b>	<b>99.27</b>	1.94	2.19	3.13
3 x 3 x 1 1/2 x 1 1/2	* <b>526184F</b>	<b>125.39</b>	2.13	4.38	3.31
3 x 3 x 2 x 2	<b>526181</b>	<b>134.72</b>	2.13	2.88	3.31
4 x 4 x 2 x 2	<b>526190F</b>	<b>254.92</b>	3.88	5.01	6.13
4 x 4 x 3 x 3	* <b>526191F</b>	<b>262.18</b>	3.88	5.38	6.13

A

**Pipe Increaser (S x S)**

Size (inch)	Part No.	USD	N (inch)
1 1/2 x 2	<b>527022</b>	<b>34.61</b>	0.53
1 1/2 x 3	<b>* 527023F</b>	<b>72.02</b>	2.63
2 x 3	<b>527024</b>	<b>41.76</b>	0.88
2 x 4	<b>527025</b>	<b>64.77</b>	1.38
3 x 4	<b>527026</b>	<b>67.67</b>	0.94
3 x 6	<b>* 527027F</b>	<b>280.83</b>	1.81
4 x 6	<b>* 527028F</b>	<b>305.70</b>	1.63

A

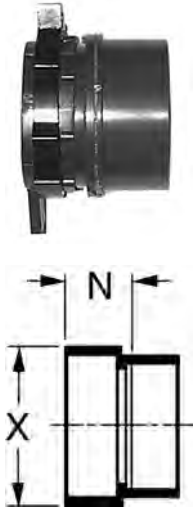
**Reducer Bushing (SPG x S)**

Size (inch)	Part No.	USD	N (inch)	X (inch)
2 x 1 1/2	<b>526752</b>	<b>24.46</b>	1.61	2.38
3 x 1 1/2	<b>526762</b>	<b>25.91</b>	1.50	3.50
3 x 2	<b>526754</b>	<b>27.36</b>	1.50	3.50
4 x 2	<b>526758</b>	<b>57.62</b>	1.13	4.50
4 x 3	<b>526756</b>	<b>61.87</b>	1.50	4.50
6 x 4	<b>526767</b>	<b>112.95</b>	1.28	6.63

A

**Cap (S)**

Size (inch)	Part No.	USD	HL (inch)
1 1/2	<b>527081</b>	<b>19.48</b>	0.53
2	<b>527082</b>	<b>22.38</b>	0.32
3	<b>527083</b>	<b>37.41</b>	0.91
4	<b>527084</b>	<b>72.02</b>	1.09
6	<b>527087</b>	<b>118.13</b>	1.56

A



### Male Adapter (S x MPT)

Size (inch)	Part No.	USD	HL (inch)
1 ½	526871	17.31	1.18
2	526872	20.21	1.25
3	526873	34.61	1.84
4	526874	72.02	2.00
6	*526876F	209.33	3.50

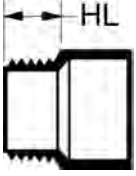

A



### Female Adapter (S x FPT)

Size (inch)	Part No.	USD	HL (inch)
1 ½	526891	25.91	1.12
2	526892	27.36	1.15
3	526893	48.91	1.72
4	526894	76.27	1.81
6	526896	136.79	2.82

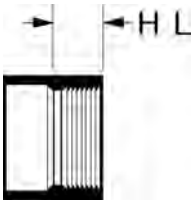

A



### Glass Pipe Adapter (SPG x Glass Pipe Bead)

Compression Coupling and Clamp available from Glass Vendor

Size (inch)	Part No.	USD	M (inch)	N (inch)	X (inch)
1 ½	*527411	28.81	2.06	2.00	1.90
2	*527412	31.71	2.58	2.00	2.38
3	*527413	40.31	3.69	2.50	3.50
4	*527414	69.12	4.84	2.50	4.50
6	*527416	93.58	7.12	3.00	6.63

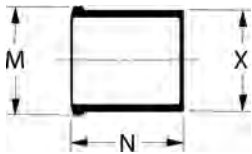



A

**Silicon Iron Pipe Adapter (S x Iron Pipe Bead)**

Silicon Iron Clamp available from Iron Pipe Vendor



Size (inch)	Part No.	USD	M (inch)	N (inch)
1 ½	* 527431	38.86	2.25	1.88
2	* 527432	40.31	2.72	2.00
3	* 527433	57.62	3.81	2.63
4	* 527434	86.32	4.81	2.63

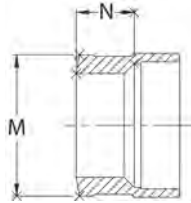

A

**Caulked Joint Adapter (S x Caulked Joint Bead)**

Use with Caulked Joint Coupling



Size (inch)	Part No.	USD	M (inch)	N (inch)
1 ½	* 527441	63.32	2.38	4.50
2	* 527442	72.02	2.88	4.25
3	* 527443	90.67	3.88	4.65
4	* 527444	118.13	4.88	4.83

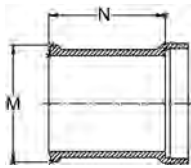

A

**Lead Pipe Adapter (S x Flare)**

Size (inch)	Part No.	USD	HL (inch)
1 ½	* 527401	38.86	1.12

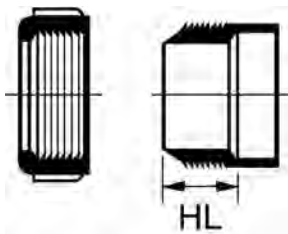

A



**Polyethylene Adapter  
(HDPE Socket x Female Union Nut)**

Use with Male Union Adapter

Size (inch)	Part No.	USD	HL (inch)
1 ½	* 527268A	38.86	0.63
2	* 527278A	40.31	0.75

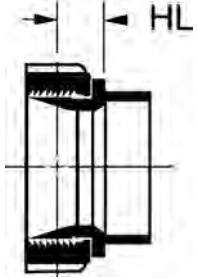

A



**Female Union Nut Adapter (S x Female Union Nut)**

Size (inch)	Part No.	USD	HL (inch)
1 ½	* 527260A	38.86	0.63
2	* 527270A	40.31	0.75



A

**Female Union Nut Adapter (SPG x Female Union Nut)**



Size (inch)	Part No.	USD	HL (inch)
1 ½	*527262A	38.86	0.63



A

**Male Union Adapter (S x Male Union)**



Size (inch)	Part No.	USD	HL (inch)
1 ½	*527264	38.86	0.44

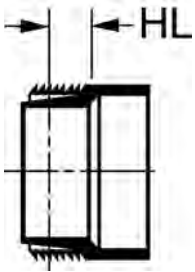

A

### Male Union Adapter (SPG x Male Union)

Size (inch)	Part No.	USD	HL (inch)
2	* 527276	38.86	0.56



A

### Male Union Adapter (MPT x Male Union)

Size (inch)	Part No.	USD	HL (inch)
2	* 527277	38.86	0.56



A

### Male Union Adapter (FPT x Male Union)

Size (inch)	Part No.	USD	HL (inch)
2	* 527275	38.86	0.50



A

## Flange - Van Stone ANSI 150 lb. Pattern (S)

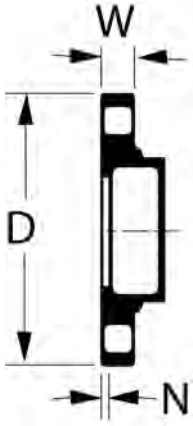

Size (inch)	Part No.	USD	# holes	bolt hole dia. (inch)	bolt cir. dia. (inch)	D (inch)	N (inch)	W (inch)
1 ½	526931	72.02	4	0.56	3.88	5.00	0.31	0.75
2	526932	76.27	4	0.68	4.75	6.00	0.34	0.81
3	526933	153.37	4	0.75	6.00	7.50	0.44	1.00
4	526934	194.82	8	0.75	7.50	9.00	0.42	1.10
6	526936	266.32	8	0.88	9.50	11.00	0.45	1.26

A

## Union (PPFR x PPFR)/PPFR Nut (S x S)

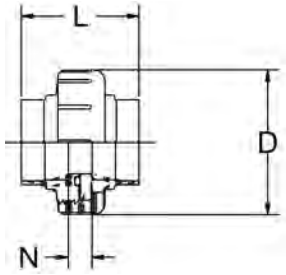

Size (inch)	FKM Part No.	USD	EPDM Part No.	USD	D (inch)	L (inch)	N (inch)
1 ½	* 528291	86.32	* 527271	79.17	3.75	3.38	0.63
2	* 528292	100.73	* 527272	90.67	4.63	3.75	0.75
3	* 528293	144.04	* 527273	124.35	6.75	4.68	0.90
4	* 528294	195.85	* 527274	180.31	8.50	5.54	1.00

A

**Expansion Joint (S x SPG)**



Size (inch)	EPDM Part No.	USD	A (inch)	B (inch)	C (inch)	D (inch)	L (inch)
1 1/2	* 527811A	118.13	0.97	4.09	0.75	2.65	4.10
2	* 527812A	161.66	1.19	4.53	0.88	3.15	4.50
3	* 527813A	216.58	1.59	5.31	0.94	4.64	5.25
4	* 527814A	266.32	2.09	6.34	0.94	5.78	5.69

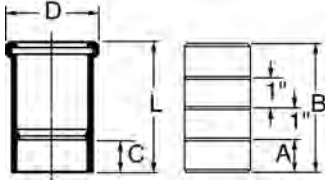

A

**Metal Transition Fitting (PPFR x SS)(SPG x SPG)**

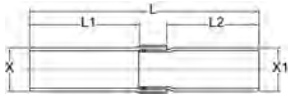

**Instruments:**

- USPH Compliant Transition

Size (inch)	Part No.	USD	L (inch)	L1 (inch)	L2 (inch)	X (inch)	X1 (inch)
2 x 2	* 528729	363.73	21.96	10.50	10.00	2.38	2.38
3 x 2 1/2	* 528730	606.22	22.13	9.50	10.13	3.50	2.88
3 x 3	* 528731	484.97	22.13	9.50	10.13	3.50	3.50
4 x 4	* 528732	1,031.09	22.63	9.50	11.50	4.50	4.50

A

**Metal Transition Fitting (PPFR x SS)(SPG x MPT)**

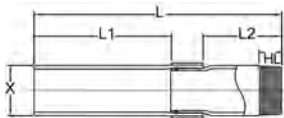

Size (inch)	Part No.	USD	L (inch)	L1 (inch)	L2 (inch)	X (inch)
2 x 2	* 528907	362.69	11.72	6.50	3.72	2.38

# Fuseal Cleanouts & Floor Drains PPR

A

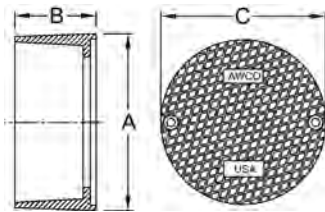

## Nickel Bronze Floor Cleanout Housing

Size (inch)	Part No.	USD	A (inch)	B (inch)	C (inch)
All	* 527715A	432.12	6.13	2.81	5.70

A

## Nickel Bronze Floor Cleanout Assembly (S)

2" adjustment



Size (inch)	Part No.	USD	A (inch)	B (inch)	C (inch)	N (inch)
3	* 527713A	468.39	6.13	2.81	5.70	2.78
4	* 527714A	503.63	6.13	2.81	5.70	3.06

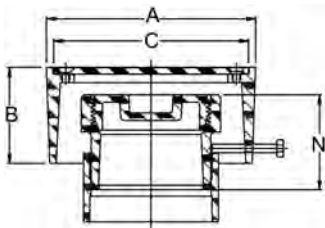

A

## Cleanout Tee with Plug (S x S x FT)



Size (inch)	Part No.	USD	HL (inch)	N (inch)
1 1/2	526114A	43.21	1.82	2.12
2	526115A	46.11	2.13	2.74
3	526116A	97.82	2.63	3.75
4	526117A	132.64	3.38	5.00
6	* 526118AF	1,079.79	7.75	18.00

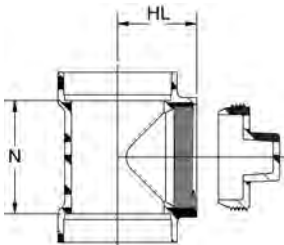

A



### Cleanout Adapter with Plug (SPG x FT)

Size (inch)	Part No.	USD	HL (inch)	N (inch)	X (inch)
1 ½	<b>527701A</b>	<b>23.11</b>	0.78	2.09	1.90
2	<b>527702A</b>	<b>27.36</b>	0.78	2.22	2.38
3	<b>527703A</b>	<b>50.36</b>	1.09	2.66	3.50
4	<b>527704A</b>	<b>97.82</b>	1.13	2.94	4.50
6	<b>527706A</b>	<b>195.85</b>	1.31	2.63	6.63

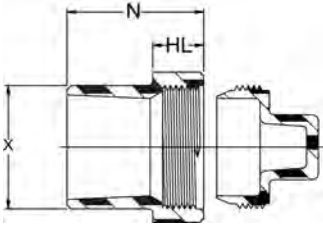

A



### Countersunk Plug for Cleanout (MT)

Size (inch)	Part No.	USD	L (inch)	Q (inch)
3	<b>* 527063</b>	<b>20.21</b>	1.03	1.31
4	<b>* 527064</b>	<b>34.61</b>	1.16	1.63

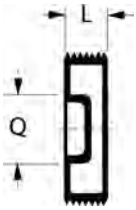

A



### Plug (MT)

Use with cleanout tees, cleanout adapters and cleanout p-traps only

Size (inch)	Part No.	USD	L (inch)	Q (inch)	Remarks
1	<b>* 527049</b>	<b>15.85</b>	0.99	0.75	Used for 527201A & 527202A
1 ½	<b>* 527051</b>	<b>17.31</b>	1.56	1.00	Used for 527203A & 527204A
2	<b>* 527052</b>	<b>18.76</b>	1.54	1.25	
3	<b>* 527053</b>	<b>21.66</b>	2.03	1.63	
4	<b>* 527054</b>	<b>34.61</b>	2.16	2.00	
6	<b>* 527057</b>	<b>43.21</b>	2.38	2.38	

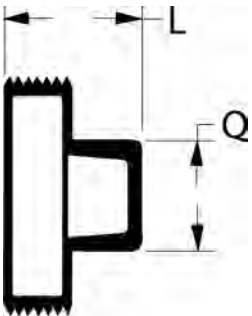



A

**Floor Drain (S)**

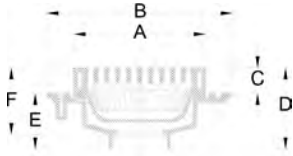

Size (inch)	Part No.	USD	A (inch)	B (inch)	C (inch)	D (inch)	E (inch)	F (inch)
2	* 527749F	309.84	8.50	12.00	1.63	6.69	5.06	5.81
3	527750	374.09	8.50	12.00	1.63	5.25	3.63	4.31
4	527751	403.11	8.50	12.00	1.63	5.25	3.63	4.31
6	* 527752F	503.63	8.50	12.00	1.63	7.26	5.63	6.00

A

**Replacement Strainer for Floor Drain**



Size (inch)	Part No.	USD
All	* 527502A	60.41

A

**Replacement Grate for Floor Drain**



Size (inch)	Part No.	USD
All	* 527503A	72.02

A

**Anti-Splash Funnel for Floor Drain**



Size (inch)	Part No.	USD	G (inch)	H (inch)
All	* 527505A	93.58	6.00	4.00

A

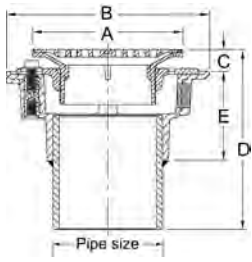

### Stainless Steel Adjustable Floor Drains

Drains have a pipe spigot end and come standard with a sediment bucket. Drain design has a section to tap for trap primer. Optional square and round grates are available.

Size (inch)	Part No.	USD	Description	A (inch)	B (inch)	D (inch)	E (inch)
2	* 150 999 100	727.46	6" Round SS drain C= 3/4 to 2 1/2"	6.00	8.38	5.00	3.00
3	* 150 999 101	770.98	6" Round SS drain C= 3/4 to 2 1/2"	6.00	8.38	6.19	3.69
4	* 150 999 102	800.00	6" Round SS drain C= 3/4 to 2 1/2"	6.00	8.38	6.31	3.81

# Fuseal Traps PPR

A

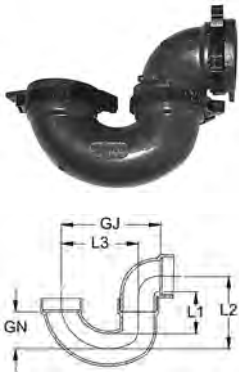

## P-Trap (SxS)

1-1/2" - 4" U-Bend Joint must be fused in the field  
6" U-Bend Joint is Factory Fused

Size (inch)	Part No.	USD	GJ (inch)	GN (inch)	L1 (inch)	L2 (inch)	L3 (inch)
1 1/2	<b>527201</b>	<b>54.72</b>	4.71	1.68	2.06	3.64	3.50
2	<b>527202</b>	<b>76.27</b>	6.94	2.44	2.71	4.75	5.06
3	<b>527203</b>	<b>144.04</b>	8.88	2.79	3.41	6.43	6.75
4	<b>527204</b>	<b>251.81</b>	10.75	3.88	3.88	8.06	8.50
6	<b>*527206F</b>	<b>654.92</b>	20.88	5.63	9.19	15.25	15.25

A



## P-Trap with Cleanout (S x S)

1-1/2" - 4" U-Bend Joint must be fused in the field

Size (inch)	Part No.	USD	GJ (inch)	GN (inch)	L1 (inch)	L2 (inch)	L3 (inch)
1 1/2	<b>*527201A</b>	<b>66.22</b>	4.71	1.68	2.06	3.64	3.50
2	<b>*527202A</b>	<b>97.82</b>	6.94	2.44	2.71	4.75	5.06
3	<b>*527203A</b>	<b>180.31</b>	8.88	2.79	3.41	6.43	6.75
4	<b>*527204A</b>	<b>302.59</b>	10.75	3.88	3.88	8.06	8.50

A



## P-Trap with Union Connection (S x S)

Size (inch)	Part No.	USD	GJ (inch)	GN (inch)	L1 (inch)	L2 (inch)	L3 (inch)
1 1/2	<b>*527211E</b>	<b>54.72</b>	4.84	1.68	2.38	4.00	3.50
2	<b>*527212E</b>	<b>82.07</b>	6.50	2.44	2.84	4.88	5.06

A



**P-Trap with Union Connection  
(Slip Joint Inlet x S)  
(Slip Joint Inlet x FPT)**

Size (inch)	(S) Part No.	USD	(FPT) Part No.	USD	GJ (inch)	GN (inch)	L1 (inch)	L2 (inch)	L3 (inch)
1 ½	* 527225	108.81	* 527235	108.81	4.51	1.80	2.08	3.71	3.30

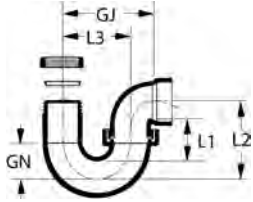

A



**Jar Trap (FPT Inlet x S Outlet)**

Size (inch)	Part No.	USD	L (inch)	L1 (inch)	N (inch)
1 ½	* 527242C	97.82	9.50	1.63	2.75

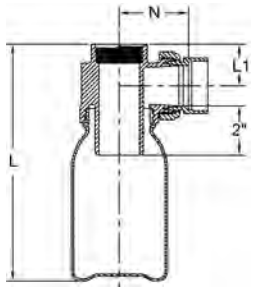

A



**Replacement Polypropylene Jar for Jar Trap  
Translucent**

Size (inch)	NFR Part No.	USD
1 Quart	* 37X005006	37.41

A



**Replacement Gasket for Jar Trap**

Size (inch)	Part No.	USD
1 Quart	* 37X002101	17.31

A



**Drum Trap with Domed Cap  
(Male Union Thread x Male Union Thread)**

Use with Union Nut Adapters: 527260A, 527270A or 527262A

Size (inch)	Part No.	USD	D (inch)	G (inch)	L (inch)	L1 (inch)	L2 (inch)
1 ½	* 527246A	266.32	6.50	4.31	13.44	2.75	4.50
2	* 527247A	338.86	6.50	4.31	13.44	2.75	4.50

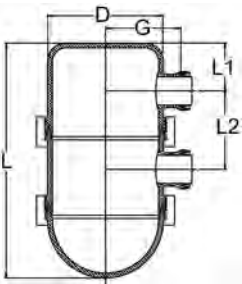

A



**Drum Trap with Flat Cap  
(Male Union Thread x Male Union Thread)**

Use with Union Nut Adapters: 527260A or 527262A

Size (inch)	Part No.	USD	D (inch)	G (inch)	L (inch)	L1 (inch)	L2 (inch)
1 ½	* 527246B	355.44	6.50	4.31	10.50	2.75	4.50

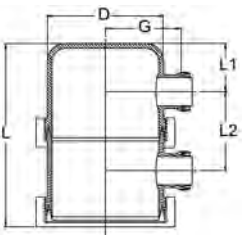

A



### Drum Trap (S x S)

Must field fuse body

Size (inch)	Part No.	USD	D (inch)	G (inch)	L (inch)	L1 (inch)	L2 (inch)
1 ½	* 527248	187.56	4.50	2.25	9.34	1.25	5.13
2	* 527249	209.33	4.50	2.38	9.34	1.35	5.13

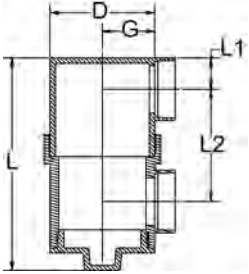

A



### P-Trap Inlet/Outlet Pipe (SPG x MPT)

Size (inch)	Part No.	USD	L (inch)	X (inch)
1 ½	* 527538	37.41	18.00	1.90

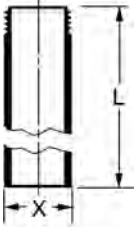

A



### Sink Strainer Assembly (MT)

Includes Sink Strainer, Gasket, Plug and Locknut

Size (inch)	Part No.	USD	L (inch)	M (inch)	R (inch)
1 ½	* 527841A	54.72	2.75	3.31	0.25

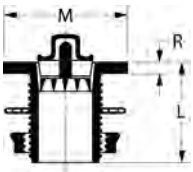

A



**Sink Strainer Adapter (FT x SPG)**

Size (inch)	Part No.	USD	D (inch)	L (inch)	X (inch)
1 ½	* 527451	20.21	2.88	3.38	1.90

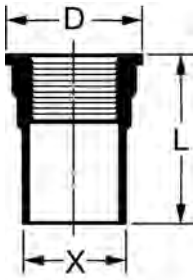

A



**Swivel Sink Strainer Adapter with Gasket (S x FT)**

Size (inch)	Part No.	USD	L (inch)	N (inch)
1 ½	* 527217	27.36	1.72	0.44

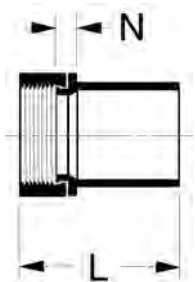

A



**Swivel Sink Strainer Adapter with Gasket (SPG x FT)**

Size (inch)	Part No.	USD	L (inch)
1 ½	* 527216	28.81	2.50
1 ½	* 527218	46.11	13.00

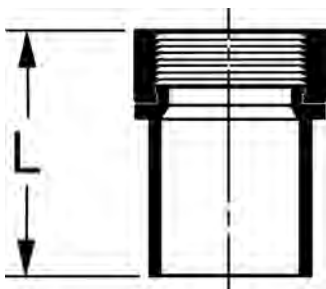

A

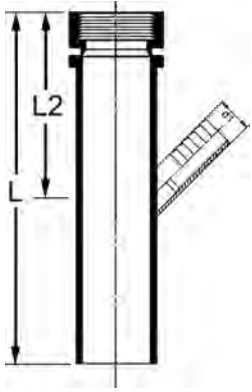

### Swivel Sink Strainer Adapter with Gasket (SPG x FT) and Dishwasher Hook-up

Size (inch)	Part No.	USD	D (inch)	L (inch)	L2 (inch)
1 ½	* 150 991 103	273.58	0.79	13.00	5.50

A



### Replacement Gasket for Swivel Sink Strainer Adapter

Material: FKM

Size (inch)	Part No.	USD	Pack Qty
1 ½	* 37X002100	11.61	5

A



### Tailpiece Adapter (SPG x Brass Nut)

Size (inch)	Part No.	USD	L (inch)	X (inch)
1 ½	* 527561	31.71	2.13	1.90

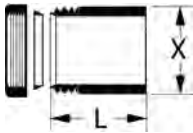

A

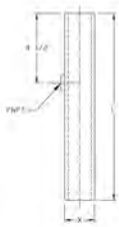

### Trap Primer with FPT Tap (SPG x SPG)

Size (inch)	Part No.	USD	L (inch)	X (inch)	FPT (inch)
1 ½	* 527221F	111.92	12.00	1.90	½
2	* 527222F	123.32	12.00	2.38	½
3	* 527223F	131.61	12.00	3.50	½
4	* 527224F	139.90	12.00	4.50	½
6	* 527226F	145.08	12.00	6.63	¾



A

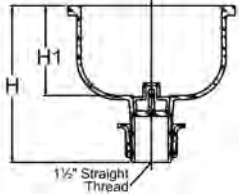
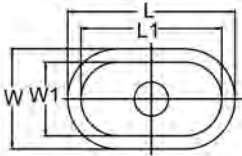

### Cup Sink - MT Outlet

Includes Sink Strainer, Plug and Retainer Nut

Size (inch)	Part No.	USD	H (inch)	H1 (inch)	L (inch)	L1 (inch)	W (inch)	W1 (inch)
1 1/2	* 527851A	64.77	7.00	4.00	9.75	8.56	4.50	3.31
1 1/2	* 527852A	90.67	7.00	4.00	7.50	6.31	4.50	3.31

A

### Replacement Parts for Cup Sink

Description	Part No.	USD
Strainer	* 527853	11.61
Plug	* 527854	11.61

# Fuseal LD Fusion Fittings PP

A

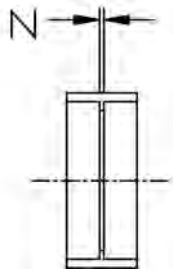

## Coupling (S x S)

Size (inch)	FR Part No.	USD	NFR Part No.	USD	N (inch)
8	* 527008	346.11		Call	0.25
10	* 527100	412.44		Call	0.25
12	* 527120	500.52		Call	0.25

A

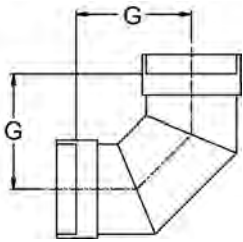

## 1/4 Bend (90°) - 3 Segment (S x S)

Size (inch)	NFR Part No.	USD	FR Part No.	USD	G (inch)
8	* 216258F	1,676.68	* 526258F	2,088.08	12.25
10	* 216255F	1,911.92	* 526255F	2,412.44	14.25
12	* 216257F	2,279.79	* 526257F	2,831.09	16.25

A

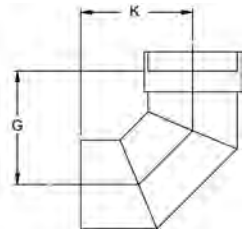

## 1/4 Bend (90°) - Street (S x SPG)

Size (inch)	NFR Part No.	USD	FR Part No.	USD	G (inch)	K (inch)
8	* 216458F	1,346.11	* 526458F	1,691.19	12.25	12.00
10	* 216455F	1,500.52	* 526455F	1,882.90	14.25	14.00
12	* 216457F	1,787.56	* 526457F	2,220.73	16.25	16.00

A

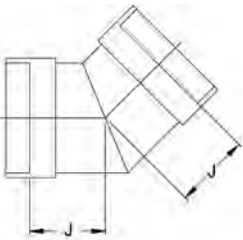

## 1/8 Bend (45°) (S x S)

Size (inch)	NFR Part No.	USD	FR Part No.	USD	J (inch)
8	* 216508F	1,382.38	* 526508F	1,728.50	6.94
10	* 216505F	1,544.04	* 526505F	1,926.42	7.75
12	* 216507F	1,868.39	* 526507F	2,338.86	8.50

A

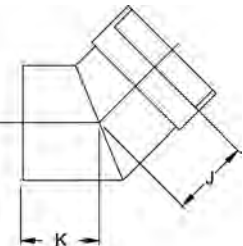

## 1/8 Bend (45°) - Street (S x SPG)

Size (inch)	NFR Part No.	USD	FR Part No.	USD	J (inch)	K (inch)
8	* 216408F	1,044.56	* 526408F	1,324.35	6.94	6.69
10	* 216405F	1,132.64	* 526405F	1,419.69	7.75	7.25
12	* 216407F	1,529.53	* 526407F	1,713.99	8.50	8.25

A

**45° Wye (S x S x S)**

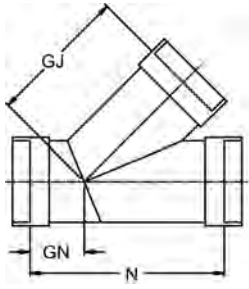

Size (inch)	NFR Part No.	USD	FR Part No.	USD	GJ (inch)	GN (inch)	N (inch)
8	* 216308F	2,721.24	* 526308F	3,419.69	15.50	7.00	22.50
10	* 216305F	3,080.83	* 526305F	3,860.10	20.75	7.75	28.50
12	* 216300F	3,809.33	* 526300F	4,764.77	22.00	8.50	30.50

A

**45° Wye - Reducing (S x S x S)**

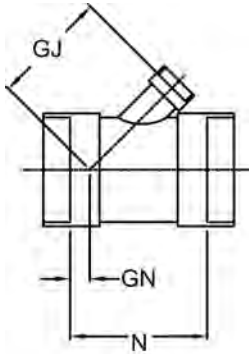

Size (inch)	NFR Part No.	USD	FR Part No.	USD	GJ (inch)	GN (inch)	N (inch)
8 x 8 x 3	* 216347T	1,640.41	* 526347T	2,059.07	10.50	1.50	12.00
8 x 8 x 4	* 216346T	1,774.09	* 526346T	2,213.47	11.00	2.00	13.00
8 x 8 x 6	* 216345T	2,177.20	* 526345T	2,721.24	12.50	3.50	16.00
10 x 10 x 3	* 216321T	3,080.83	* 526321T	3,860.10	12.00	2.00	14.00
10 x 10 x 4	* 216322T	3,080.83	* 526322T	3,860.10	12.63	2.13	14.75
10 x 10 x 6	* 216323T	3,080.83	* 526323T	3,860.10	14.50	4.00	18.50
10 x 10 x 8	* 216324T	3,132.64	* 526324T	3,919.17	15.75	5.25	21.00
12 x 12 x 4	* 216332T	2,729.53	* 526332T	4,021.76	14.00	1.50	15.50
12 x 12 x 6	* 216333T	3,265.28	* 526333T	4,080.83	15.50	3.00	18.50
12 x 12 x 8	* 216334T	3,308.81	* 526334T	4,168.91	17.25	4.50	24.75
12 x 12 x 10	* 216335T	3,353.37	* 526335T	5,844.56	19.25	6.00	25.25

A

**45° Wye - Double (S x S x S x S)**

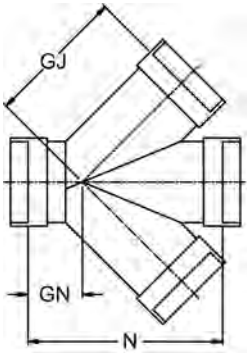

Size (inch)	NFR Part No.	USD	FR Part No.	USD	GJ (inch)	GN (inch)	N (inch)
8	* 216352F	2,721.24	* 526352F	2,721.24	15.50	7.00	22.50
10	* 216355F	3,809.33	* 526355F	4,779.27	20.75	7.75	28.50
12	* 216350F	4,256.99	* 526350F	5,347.15	22.00	8.50	30.50

A

**45° Wye - Double Reducing (S x S x S x S)**

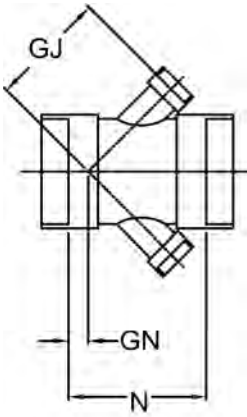

Size (inch)	NFR Part No.	USD	FR Part No.	USD	GJ (inch)	GN (inch)	N (inch)
8 x 8 x 3 x 3	* 216389T	2,272.54	* 526393T	2,831.09	10.50	1.50	12.00
8 x 8 x 4 x 4	* 216388T	2,353.37	* 526391T	2,963.73	11.00	2.00	13.00
8 x 8 x 6 x 6	* 216386T	2,455.96	* 526392T	3,066.32	12.50	3.50	16.00
10 x 10 x 3 x 3	* 216370T	2,992.75	* 526370T	3,757.51	13.18	2.18	15.38
10 x 10 x 4 x 4	* 216371T	3,088.08	* 526371T	3,845.60	12.63	2.13	14.75
10 x 10 x 6 x 6	* 216372T	3,265.28	* 526372T	4,088.08	14.50	4.00	18.50
10 x 10 x 8 x 8	* 216373T	3,441.45	* 526373T	4,353.37	15.75	5.25	21.00
12 x 12 x 4 x 4	* 216382T	3,441.45	* 526394T	4,353.37	14.00	1.50	15.50
12 x 12 x 6 x 6	* 216383T	3,441.45	* 526395T	4,353.37	15.50	3.00	18.50
12 x 12 x 8 x 8	* 216384T	3,544.04	* 526396T	4,448.70	17.25	4.50	21.75
12 x 12 x 10 x 10	* 216385T	3,992.75	* 526397T	4,985.49	19.25	6.00	25.25

A

**Combo Wye & 1/8 Bend (90°) (S x S x S)**

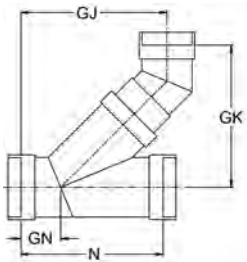

Size (inch)	NFR Part No.	USD	FR Part No.	USD	GJ (inch)	GK (inch)	GN (inch)	N (inch)
8	* 216716F	3,080.83	* 526716F	3,897.41	22.63	22.63	7.00	22.50
10	* 216700F	4,346.11	* 526700F	5,434.20	27.75	27.75	7.75	28.50
12	* 216701F	5,073.58	* 526701F	6,360.62	30.00	30.00	8.50	30.50

A

**Combo Wye & 1/8 Bend (90°) - Reducing (S x S x S)**

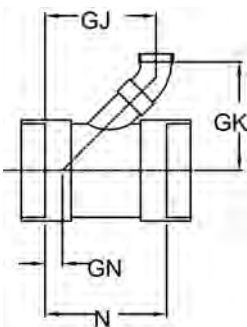

Size (inch)	NFR Part No.	USD	FR Part No.	USD	GJ (inch)	GK (inch)	GN (inch)	N (inch)
8 x 8 x 3	* 216709T	2,265.28	* 526709T	2,845.60	11.25	11.50	1.50	12.00
8 x 8 x 4	* 216717T	2,316.06	* 526717T	2,904.66	12.00	12.25	2.00	13.00
8 x 8 x 6	* 216715T	2,360.62	* 526715T	2,949.22	15.69	15.56	3.50	16.00
10 x 10 x 3	* 216707T	3,258.03	* 526707T	4,080.83	12.81	12.56	2.00	14.00
10 x 10 x 4	* 216721T	3,308.81	* 526721T	4,154.40	13.38	13.44	2.13	14.75
10 x 10 x 6	* 216711T	3,353.37	* 526711T	4,213.47	17.63	17.00	4.00	18.50
10 x 10 x 8	* 216712T	3,632.12	* 526712T	4,529.53	21.13	22.75	5.25	21.00
12 x 12 x 4	* 216720T	3,712.95	* 526720T	4,669.43	13.69	14.38	1.50	15.50
12 x 12 x 6	* 216718T	3,809.33	* 526718T	4,757.51	17.31	17.69	3.00	18.50
12 x 12 x 8	* 216719T	3,992.75	* 526719T	4,985.49	21.44	23.81	4.50	24.75
12 x 12 x 10	* 216710T	4,080.83	* 526710T	5,109.84	24.88	26.69	6.00	25.25

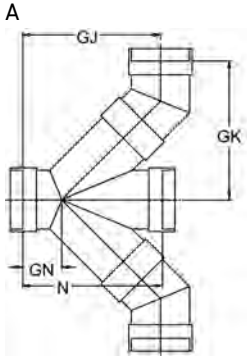

**Combo Wye (90°) - Double (S x S x S x S)**

Size (inch)	NFR Part No.	USD	FR Part No.	USD	GJ (inch)	GK (inch)	GN (inch)	N (inch)
8	* 216816F	3,632.12	* 526816F	4,529.53	22.63	22.63	7.00	22.50
10	* 216800F	4,985.49	* 526800F	6,248.70	27.75	27.75	7.75	28.50
12	* 216801F	6,347.15	* 526801F	7,977.20	30.00	30.00	8.50	30.50

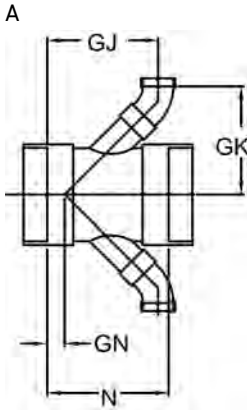

**Combo Wye (90°) - Double Reducing (S x S x S x S)**

Size (inch)	NFR Part No.	USD	FR Part No.	USD	GJ (inch)	GK (inch)	GN (inch)	N (inch)
8 x 8 x 3 x 3	* 216809T	2,536.79	* 526809T	3,168.91	11.25	11.50	1.50	12.00
8 x 8 x 4 x 4	* 216817T	2,721.24	* 526817T	3,441.45	12.00	12.25	2.00	13.00
8 x 8 x 6 x 6	* 216815T	2,904.66	* 526815T	3,624.87	15.69	15.56	3.50	16.00
10 x 10 x 3 x 3	* 216807T	3,632.12	* 526807T	3,059.07	12.81	12.56	2.00	14.00
10 x 10 x 4 x 4	* 216821T	3,809.33	* 526821T	4,809.33	13.38	13.44	2.13	14.75
10 x 10 x 6 x 6	* 216811T	4,088.08	* 526811T	5,109.84	17.63	17.00	4.00	18.50
10 x 10 x 8 x 8	* 216812T	4,265.28	* 526812T	5,345.08	21.13	22.75	5.25	21.00
12 x 12 x 4 x 4	* 216820T	4,712.95	* 526820T	5,904.66	13.69	14.38	1.50	15.50
12 x 12 x 6 x 6	* 216818T	4,897.41	* 526818T	6,161.66	17.31	17.69	3.00	18.50
12 x 12 x 8 x 8	* 216819T	5,073.58	* 526819T	6,345.08	21.44	23.81	4.50	21.75
12 x 12 x 10 x 10	* 216810T	5,256.99	* 526810T	6,610.36	24.88	26.69	6.00	25.25

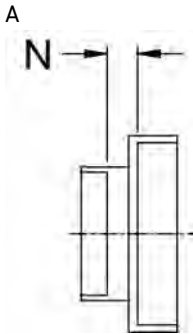

**Pipe Increaser (S x S)**

Size (inch)	NFR Part No.	USD	FR Part No.	USD	N (inch)
8 x 3		Call	* 527035F	823.83	2.00
8 x 4		Call	* 527034F	1,089.12	1.75
8 x 6		Call	* 527033F	1,184.46	1.63
10 x 3	* 217040F	1,089.12	* 527040F	1,367.88	1.00
10 x 4	* 217030F	1,184.46	* 527030F	1,470.47	1.18
10 x 6	* 217031F	1,268.39	* 527031F	1,640.41	1.50
10 x 8	* 217032F	1,367.88	* 527032F	2,265.28	2.13
12 x 4	* 217036F	1,676.68	* 527036F	2,088.08	1.00
12 x 6	* 217037F	1,772.02	* 527037F	2,213.47	1.50
12 x 8	* 217038F	1,861.14	* 527038F	2,360.62	2.00
12 x 10	* 217039F	1,904.66	* 527039F	2,455.96	3.00



**Cap (S)**

Size (inch)	NFR Part No.	USD	FR Part No.	USD	HL (inch)
8		Call	* 527088	238.34	1.81
10	* 217090F	640.41	* 527090F	823.83	3.38
12	* 217092F	780.31	* 527092F	1,000.00	3.38

A

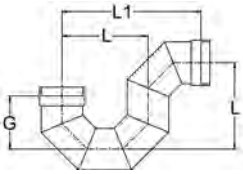

### P-Trap (S x S)

Size (inch)	NFR Part No.	USD	FR Part No.	USD	G (inch)	L (inch)	L1 (inch)
8	* 217208F	4,007.25	* 527208F	4,897.41	12.25	18.25	30.50
10	* 217210F	4,558.55	* 527210F	5,808.29	14.25	22.25	36.50
12	* 217212F	5,256.99	* 527212F	6,544.04	16.25	26.50	42.75

A

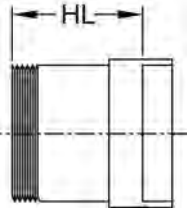

### Male Adapter (S x MPT)

Size (inch)	NFR Part No.	USD	HL (inch)
8	* 216878F	683.94	4.38

A

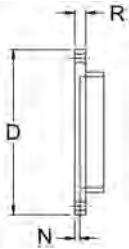

### Flange - Van Stone ANSI 150 lb. Pattern (S)

Flange Ring Material: CPVC

Size (inch)	NFR Part No.	USD	# holes	bolt hole dia. (inch)	bolt cir. dia. (inch)	D (inch)	N (inch)	R (inch)	Bolt Length (inch)
8	* 216928	728.50	8	0.88	11.75	13.50	0.44	1.71	3.50
10	* 216930	1,000.00	12	1.00	14.25	16.00	0.50	1.73	3.75
12	* 216932	1,088.08	12	1.00	17.00	19.00	0.50	1.71	4.00

A

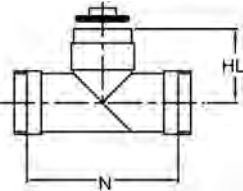

### Cleanout Tee with Plug (S x S x FT)

Size (inch)	NFR Part No.	USD	HL (inch)	N (inch)
8	* 216119AF	3,176.17	11.00	22.50
10	* 216120AF	4,176.17	14.00	28.50
12	* 216121AF	5,073.58	15.00	30.50

A

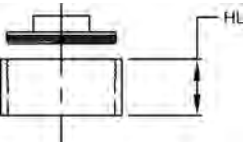

### Cleanout Adapter with Plug (SPG x FT)

Size (inch)	NFR Part No.	USD	HL (inch)
8	* 217708AF	1,360.62	4.00
10	* 217710AF	2,000.00	5.00
12	* 217712AF	2,544.04	5.00

# Fuseal Fusion Accessories

B



## Fusion Locking Collar with Plastic Clamp

6" Fusion Locking Collars without plastic clamp

Size (inch)	Part No.	USD	Pack Qty
1 1/2	* 526042	10.16	10
2	* 526043	11.61	10
3	* 526044	12.95	10
4	* 526045	16.58	10
6	* 526047	18.03	10

B



## Loose Coil

Size (inch)	Part No.	USD	Pack Qty
8	* 37B160808	33.89	10
10	* 37B160810	35.34	10
12	* 37B160812	39.79	10

B



## Plastic Clamp

Size (inch)	Part No.	USD	weight (lb)	Pack Qty
1 1/2	* 37A160601	3.21	0.022	10
2	* 37A160602	5.08	0.033	10
3	* 37A160603	5.80	0.042	10
4	* 37A160604	7.98	0.110	10

B



## Metal Clamp

Size (inch)	Part No.	USD	weight (lb)	Pack Qty
6	* 37Z000600	80.93	0.399	1
8	* 37Z000800	91.19	0.500	1
10	* 37Z001000	115.03	0.600	1
12	* 37Z001200	124.35	0.600	1

D



### Channel Locks

Size (inch)	Part No.	USD	Description	Pack Qty
1 1/2, 2, & 3	* 37X004817	44.04	440 Channel Locks	1
4	* 37X004818	71.24	460 Channel Locks	1

---



# Fuseal Mechanical Joint Fittings PPR

A

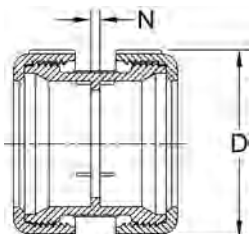

## Coupling (MJ x MJ)

Size (inch)	Part No.	USD	Pack Qty	D (inch)	N (inch)
1 ½	539001	20.93	4	2.75	0.13
2	539002	24.15	2	3.25	0.13
3	539003	48.19	1	5.25	0.25
4	539004	53.26	1	6.63	0.25

A

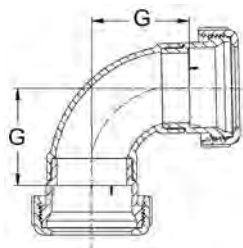

## 1/4 Bend (91.2°) - Short Sweep (MJ x MJ)

Size (inch)	Part No.	USD	Pack Qty	G (inch)
1 ½	538251	24.15	4	1.75
2	538252	30.57	2	2.31
3	538253	82.07	1	3.07
4	538254	97.82	1	3.88

A

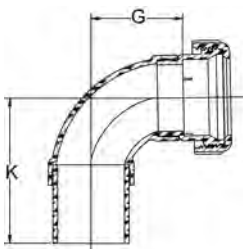

## 1/4 Bend (91.2°) - Street (MJ x SPG)

Size (inch)	Part No.	USD	Pack Qty	G (inch)	K (inch)
1 ½	538451	22.69	4	1.75	3.10
2	538452	27.36	2	2.31	3.75
3	538453	72.02	1	3.07	4.77
4	538454	90.67	1	3.88	6.08

A

**1/8 Bend (45°) (MJ x MJ)**

Size (inch)	Part No.	USD	Pack Qty	J (inch)
1 1/2	<b>538501</b>	<b>24.15</b>	4	1.09
2	<b>538502</b>	<b>30.57</b>	2	1.41
3	<b>538503</b>	<b>82.07</b>	1	1.38
4	<b>538504</b>	<b>97.82</b>	1	1.50

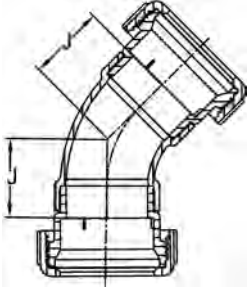

A

**1/8 Bend (45°) - Street (MJ x SPG)**

Size (inch)	Part No.	USD	Pack Qty	J (inch)	K (inch)
1 1/2	<b>538401</b>	<b>22.69</b>	4	1.13	2.45
2	<b>538402</b>	<b>27.36</b>	2	1.41	2.84
3	<b>538403</b>	<b>72.02</b>	1	1.38	3.23
4	<b>538404</b>	<b>90.67</b>	1	1.50	3.75

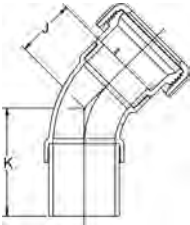

A

**45° Wye (MJ x MJ x MJ)**

Size (inch)	Part No.	USD	Pack Qty	GJ (inch)	GN (inch)	N (inch)
1 1/2	<b>538301</b>	<b>30.98</b>	4	3.25	1.13	4.00
2	<b>538302</b>	<b>45.39</b>	2	4.13	1.38	5.00
3	<b>538303</b>	<b>133.68</b>	1	5.75	1.63	7.38
4	<b>538304</b>	<b>153.37</b>	1	7.38	1.88	9.25

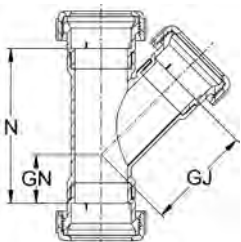

A

**45° Wye - Reducing (MJ x MJ x MJ)**



Size (inch)	Part No.	USD	Pack Qty	GJ (inch)	GN (inch)	N (inch)
2 x 2 x 1 1/2	538325	54.72	2	5.75	1.38	5.00
3 x 3 x 1 1/2	538324	118.13	1	8.50	1.63	7.38
3 x 3 x 2	538326	133.68	1	8.50	1.63	7.38
4 x 4 x 2	538328	153.37	1	10.30	1.88	9.25
4 x 4 x 3	538327	161.66	1	10.06	1.88	9.25

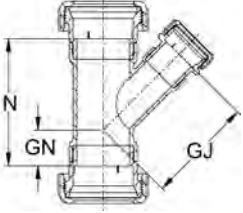

A

**Combo Wye & 1/8 Bend (90°) (MJ x MJ x MJ)**



Size (inch)	Part No.	USD	Pack Qty	GJ (inch)	GN (inch)	N (inch)
1 1/2	539301	54.72	4	5.13	5.13	4.00
2	539302	72.02	2	6.31	6.25	5.00
3	539303	144.04	1	7.90	8.15	7.38
4	539304	180.31	1	9.54	9.92	9.25

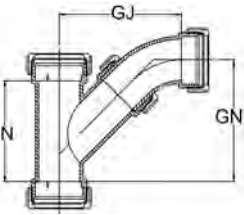

A

**Combo Wye & 1/8 Bend (90°) - Reducing (MJ x MJ x MJ)**



Size (inch)	Part No.	USD	Pack Qty	GJ (inch)	GN (inch)	N (inch)
2 x 2 x 1 1/2	539320	72.02	2	7.94	6.31	5.00
3 x 3 x 1 1/2	539326	118.13	1	8.86	9.35	7.38
3 x 3 x 2	539327	133.68	1	9.25	9.45	7.38
4 x 4 x 2	539337	153.37	1	12.04	9.77	9.25
4 x 4 x 3	539338	160.62	1	11.98	9.92	9.25

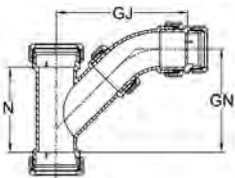

A

**Sanitary Tee (91.2°) (MJ x MJ x MJ)**



Size (inch)	Part No.	USD	Pack Qty	GJ (inch)	GN (inch)	N (inch)
1 1/2	<b>538151</b>	<b>37.41</b>	4	1.75	1.75	3.00
2	<b>538152</b>	<b>54.72</b>	2	2.31	2.31	3.69
3	<b>538153</b>	<b>144.04</b>	1	3.06	3.31	4.88
4	<b>538154</b>	<b>180.31</b>	1	3.88	3.97	6.13

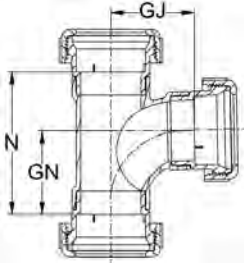

A

**Sanitary Tee (91.2°) - Reducing (MJ x MJ x MJ)**



Size (inch)	Part No.	USD	Pack Qty	GJ (inch)	GN (inch)	N (inch)
2 x 2 x 1 1/2	<b>538126</b>	<b>47.56</b>	2	3.92	2.38	3.69
3 x 3 x 1 1/2	<b>538131</b>	<b>118.13</b>	1	5.54	3.42	4.88
3 x 3 x 2	<b>538130</b>	<b>125.39</b>	1	5.54	3.42	4.88
4 x 4 x 2	<b>538134</b>	<b>144.04</b>	1	6.43	4.11	6.13
4 x 4 x 3	<b>538136</b>	<b>160.62</b>	1	6.32	4.10	6.13

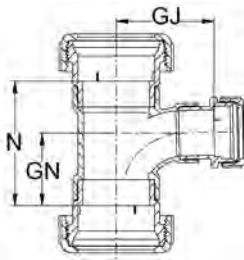

A

**Reducer Bushing (Spg x MJ)**



Size (inch)	Part No.	USD	Pack Qty	HL (inch)
2 x 1 1/2	<b>538752</b>	<b>18.76</b>	2	1.61
3 x 1 1/2	<b>538762</b>	<b>46.11</b>	1	2.48
3 x 2	<b>538754</b>	<b>54.72</b>	1	2.48
4 x 2	<b>538758</b>	<b>73.47</b>	1	2.55
4 x 3	<b>538756</b>	<b>90.67</b>	1	2.44

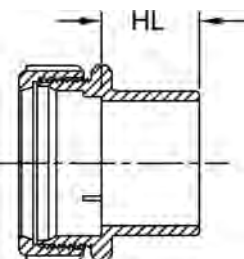

A

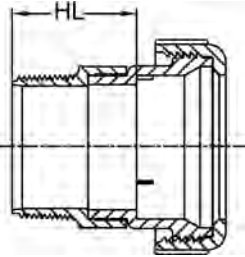

### Male Adapter (MJ x MPT)

Size (inch)	Part No.	USD	Pack Qty	HL (inch)
1 ½	538871	16.99	4	1.19
2	538872	20.93	2	1.22
3	538873	63.32	1	1.90
4	538874	90.67	1	2.00

A

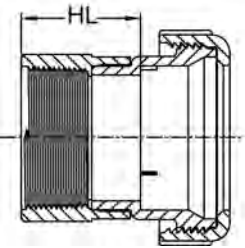

### Female Adapter (MJ x FPT)

Size (inch)	Part No.	USD	Pack Qty	HL (inch)
1 ½	538891	16.99	4	1.19
2	538892	20.93	2	1.22
3	538893	63.32	1	2.93
4	538894	90.67	1	3.00

A

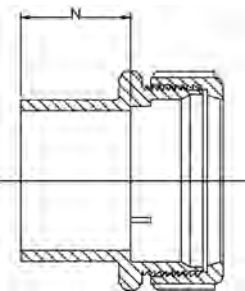

### Fuseal Adapter (MJ x Spg)

Size (inch)	Part No.	USD	Pack Qty	N (inch)
1 ½	539651	21.66	4	1.49
2	539652	24.46	2	1.17
3	539653	38.86	1	1.19
4	539654	54.72	1	1.20

A

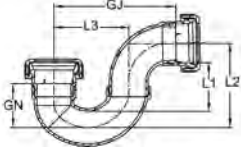

**P-Trap (MJ x MJ)**

1-1/2" & 2" U-Bend Joint is a Unon Nut Connection  
 3" & 4" U-Bend Joint is Factory Fused

Size (inch)	Part No.	USD	Pack Qty	GJ (inch)	GN (inch)	L1 (inch)	L2 (inch)	L3 (inch)
1 1/2	<b>539211E</b>	<b>54.72</b>	4	5.25	1.68	3.04	4.79	3.50
2	<b>539212E</b>	<b>80.62</b>	2	8.40	4.04	2.77	4.96	5.06
3	<b>539213E</b>	<b>134.72</b>	2	10.06	3.94	4.32	7.56	6.75
4	<b>539214E</b>	<b>251.81</b>	2	12.38	5.06	5.75	10.00	8.50

A

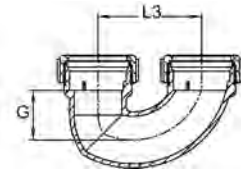

**U Bend (MJ x MJ)**

Size (inch)	Part No.	USD	Pack Qty	G (inch)	L3 (inch)
1 1/2	<b>539211</b>	<b>37.41</b>	2	1.68	3.50

A

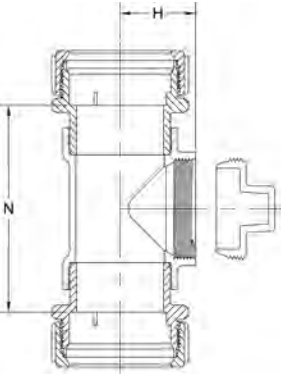

**Cleanout Tee with Plug (MJ x MJ x FT)**

Size (inch)	Part No.	USD	Pack Qty	HL (inch)	N (inch)
1 1/2	<b>* 536114A</b>	<b>83.52</b>	2	1.82	5.10
2	<b>* 536115A</b>	<b>100.73</b>	2	2.13	5.08
3	<b>* 536116A</b>	<b>197.93</b>	2	2.63	6.13
4	<b>* 536117A</b>	<b>244.56</b>	2	3.38	7.40

A



**MJ Kit**

Includes Nut, Seal Ring and Grab Ring

Size (inch)	Part No.	USD	Pack Qty
1 1/2	<b>* 536051</b>	<b>17.31</b>	10
2	<b>* 536052</b>	<b>17.31</b>	10
3	<b>* 536053</b>	<b>28.81</b>	10
4	<b>* 536054</b>	<b>28.81</b>	10

A



### Spanner Wrench

Size (inch)	Part No.	USD	Pack Qty
1 1/2 & 2	* 538100	46.84	1
3 & 4	* 538101	62.59	1

---

# Neutralization and Dilution Tanks

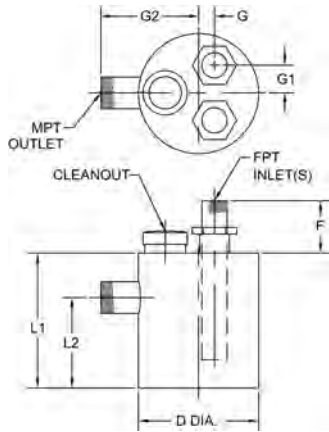

**HDPE Round Dilution Tank with Cleanout - Black (FPT Inlet x MPT Outlet)**

Size (gal)	Part No.	USD
1.5	* PETANK-9151B	338.00
1.5	* PETANK-9152B	364.00

Size (gal)	Standard Inlet (inch)	Standard Outlet (inch)	No. of Inlets	D (inch)	F (inch)	G (inch)	G1 (inch)	G2 (inch)	L1 (inch)	L2 (inch)
1.5	1 ½	2	1	9.00	0 to 12	1.19	2.06	7.31	10.16	6.78
1.5	1 ½	2	2	9.00	0 to 12	1.19	2.06	7.31	10.16	6.78

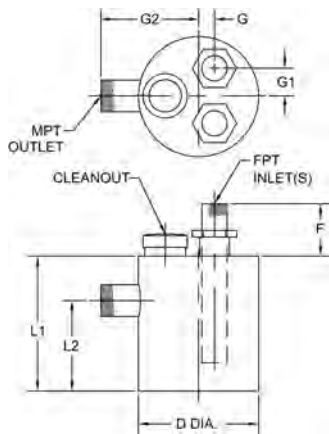

**HDPE Round Dilution Tank with Cleanout - Translucent (FPT Inlet x MPT Outlet)**

Size (gal)	Part No.	USD
1.5	* PETANK-9151T	338.00
1.5	* PETANK-9152T	374.00

Size (gal)	Standard Inlet (inch)	Standard Outlet (inch)	No. of Inlets	D (inch)	F (inch)	G (inch)	G1 (inch)	G2 (inch)	L1 (inch)	L2 (inch)
1.5	1 ½	2	1	9.00	0 to 12	1.19	2.06	7.31	10	6.78
1.5	1 ½	2	2	9.00	0 to 12	1.19	2.06	7.31	10	6.78

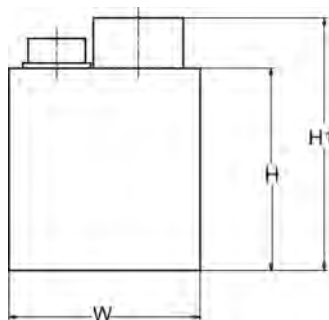

**HDPE Rectangular Dilution Tank with Cleanout - Black (FPT Inlet x FPT Outlet)**

Size (gal)	Part No.	USD	Standard Inlet/Outlet (inch)	H (inch)	H1 (inch)	L (inch)	W (inch)
1.5	* PETANK-815	352.00	1 ½	9.00	11.25	12.94	8.50
1.5	* PETANK-802	382.00	2	9.00	11.25	12.94	8.50

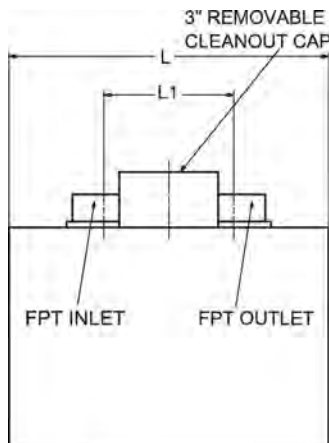



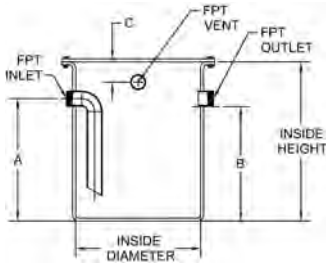

**Round Neutralization Tank, Bolted Top  
(FPT Inlet x FPT Outlet x FPT Vent)**

- Actual holding capacity based on outlet invert height and limestone displacement. Welded cover is available; contact GF for pricing. In lieu of added tank extensions as catalogued by other tank manufacturers, GF will fabricate one piece tanks to the required heights as dictated by fitting elevations in relationship to finished grade. These custom tanks will be priced on application. B dimension listed to calculate actual tank volumes (liquid capacity). For any deviations from the standard dimensions below, please note this on the Round Neutralization Tank Order Sheet.

Size (gal)	Polyethylene Part No.	USD	Polypropylene Part No.	USD
5	* PETANK-005	619.69	* PPTANK-005	840.41
15	* PETANK-015	891.19	* PPTANK-015	1,300.52
30	* PETANK-030	1,226.94	* PPTANK-030	1,330.57
55	* PETANK-055	1,500.52	* PPTANK-055	1,680.83
100	* PETANK-100	1,880.83	* PPTANK-100	2,416.58
150	* PETANK-150	2,417.62	* PPTANK-150	2,494.30
180	* PETANK-180	3,162.69	* PPTANK-180	3,031.09
200	* PETANK-200	3,345.08	* PPTANK-200	3,501.55
275	* PETANK-275	3,907.77	* PPTANK-275	4,202.07
360	* PETANK-360	4,048.70	* PPTANK-360	5,683.94
500	* PETANK-500	4,929.53	* PPTANK-500	7,709.84
1000	* PETANK-1000	11,502.59	* PPTANK-1000	8,267.36
1200	* PETANK-1200	10,538.86	* PPTANK-1200	8,626.94

Size (gal)	Inside Dimension Dia. x Ht. (inch)	Standard In- let/Outlet (inch)	Standard Vent (FPT) (inch)	A (inch)	B (inch)	C (inch)
5	11 x 14	2	2	11.00	10.00	3.00
15	18 x 15	3	2	11.00	10.00	3.00
30	18 x 29	3	2	22.00	21.00	3.00
55	22 x 36	3	2	27.00	26.00	3.00
100	28 x 42	4	3	36.00	35.00	3.00
150	31 x 48	4	3	38.00	37.00	3.00
180	36 x 42	4	3	38.00	37.00	3.00
200	36 x 48	4	3	38.00	37.00	3.00
275	42 x 48	4	3	38.00	37.00	3.00
360	48 x 48	4	3	38.00	37.00	3.00
500	52 x 60	4	3	52.00	51.00	3.00
1000	66 x 72	6	4	64.00	63.00	3.00
1200	69 x 84	6	4	72.00	71.00	3.00

**Limestone Chips (50 lb bag)**

Size (inch)	Part No.	USD	weight (lb)
1 to 3	* 37X005802	63.21	50.000

# pH Monitoring Systems



## GFS 600 pH Monitoring System

Panel Includes:

- NEMA IV enclosure
- Circular Chart Recorder (4" diameter charts)
- System On/Off Switch
- System On Light
- pH Out of Spec. Hi/Low Alarm and Light
- Alarm Test & Amp; Silence Buttons
- Alarm Horn
- Two Dry Contacts for Connection to Building Management System (BMS)
- pH Transmitter (GF Signet Model 9900 panel mount)
- pH Electrode (GF Signet Model 2724; Model 2750 Sensor Electronic)

Part No.	USD	weight (kg)
* 37Z000720	9,103.63	50.000

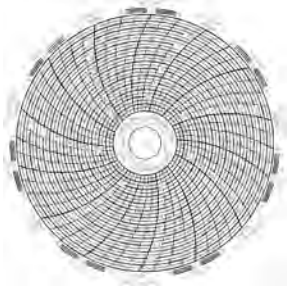

## Replacement Charts for Recorder (4" dia.)

52 charts per pack

Part No.	USD	weight (lb)	Pack Qty
* 37X005800	105.70	0.500	1

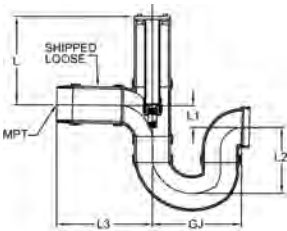

## U-Trap Assembly (MPT x S)

Size (inch)	Part No.	USD	GJ (inch)	L (inch)	L1 (inch)	L2 (inch)	L3 (inch)
3	* 37Z000703	1,121.24	8.88	14.12	3.75	6.43	10.00
4	* 37Z000704	1,261.14	10.75	14.63	2.63	8.06	12.00
6	* 37Z000706	1,891.19	20.88	12.88	6.38	15.25	20.63

# GF Piping Systems

## Corrosive Waste Piping System Specification Submittal Data Sheet Fuseal Polypropylene Pipe and Fittings

### Pipe

Pipe will be manufactured to the dimensions and tolerances of ASTM F1412. The polypropylene material will be either flame retardant (FR) or non flame retardant (NFR) and will conform to ASTM D4101. The pipe will conform to NSF-cw, CSA, UPC®, the City of Los Angeles and the Commonwealth of Massachusetts standards.

- PPR Sch.40 Group I Pipe - 10 ft. Lengths
- PPNFR Sch.40 Group I Pipe - 20 ft. Lengths
- PPNFR Sch.80 Group II Pipe - 20 ft. Lengths

### Fittings

Molded and fabricated fittings will be manufactured to the dimensions and tolerances of ASTM F1412. Molded fitting patterns will conform to ASTM D3311. The polypropylene material will conform to ASTM D4101. The fittings will conform to NSF-cw, CSA, UPC®, the City of Los Angeles and the Commonwealth of Massachusetts standards.

- PPR Sch.40 Molded
- PPR Sch.40 Fabricated
- PPNFR Sch.40 Fabricated

### Joining

Pipe and fittings are joined by either electrofusion or by mechanical joint. Electrofusion joints will conform to ASTM F1290 and consist of a polypropylene jacked wire. Mechanical joints shall consist of a seal and grab ring with chemical resistance equal to the pipe and fittings and should only be installed in accessible locations.

- Electrofusion
- Mechanical Joint

Job Name: \_\_\_\_\_

Job Location: \_\_\_\_\_

Engineer: \_\_\_\_\_

Contractor: \_\_\_\_\_

Representative: \_\_\_\_\_

# GF Piping Systems

## Round Neutralization Tank Order Sheet

Mark desired location of tank's connections by inserting I (inlet), O (outlet), and V (vent) in the diagram below.

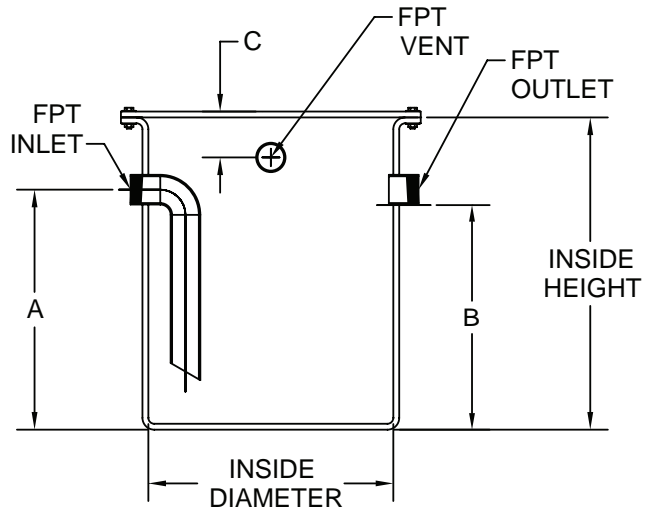
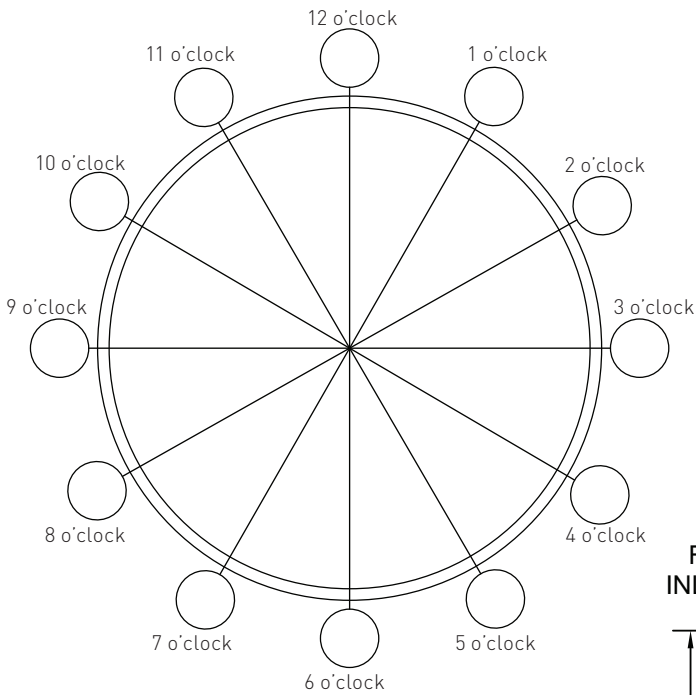

Part Number: \_\_\_\_\_

Size (gallons): \_\_\_\_\_

Material (PP or PE): \_\_\_\_\_

Inlet Size: \_\_\_\_\_ inches @ \_\_\_\_\_ o'clock (FPT unless noted)

Outlet Size: \_\_\_\_\_ inches @ \_\_\_\_\_ o'clock (FPT unless noted)

Vent Size: \_\_\_\_\_ inches @ \_\_\_\_\_ o'clock (FPT unless noted)

Tank Diameter (inside): \_\_\_\_\_

Tank Height (inside): \_\_\_\_\_

Inlet (A) Height (from bottom): \_\_\_\_\_

Outlet (B) Height (from bottom): \_\_\_\_\_

Vent (C) Depth (from top): \_\_\_\_\_

\*B Dimension listed to calculate actual tank volume (liquid capacity)

P0801087

All tanks are custom-made to the supplied specifications and are not returnable.

An authorized drawing is to be furnished for proper dimensions and locations of connections. No order will be accepted without order sheet. Once the order is accepted, the tank is non-cancelable.

In lieu of added tank extensions as catalogued by other tank manufacturers, Georg Fischer will fabricate one piece tanks to the required heights as dictated by fitting elevations in relationship to finished grade. These custom tanks will be priced on application.

# GF Piping Systems

Corrosive Waste Piping System  
Specification Submittal Data Sheet  
Acid Neutralization Tank

## Tanks

Tanks shall be seamless construction with uniform wall thickness. The inlet, outlet and vent connections are welded into the tank wall at specified locations. Tanks are complete with a bolt-down cover, gasketing and the necessary bolts, nuts and washers or in welded cover styles with a manhole. Tanks may also be fiberglass reinforced. Tanks shall be tested by filling with water prior to use and inspect for any leaks.

Polyethylene tanks are rotationally molded from virgin High-Density Polyethylene resins conforming to ASTM D4976 for Polyolefin materials and suitable for continuous duty to 160°F, intermittent duty to 200°F. All fittings are molded polyethylene.

Polypropylene tanks are rotationally molded from natural (white) virgin Polypropylene resins conforming to ASTM D4101 for Polyolefin materials and suitable for continuous duty to 180°F, intermittent duty to 212°F. All fittings are molded flame retardant polypropylene. In lieu of added tank extensions as catalogued by other tank manufacturers, Georg Fischer will fabricate one piece tanks to the required heights as dictated by fitting elevations in relationship to finished grade. These custom tanks will be priced on application.

- HDPE Tank
- PP Tank
- Fiberglass Reinforced
- Bolted Cover
- Welded Cover
- Standard Inlet, Outlet and Vent Connections
- State of Ohio Code Inlet and Outlet Connections

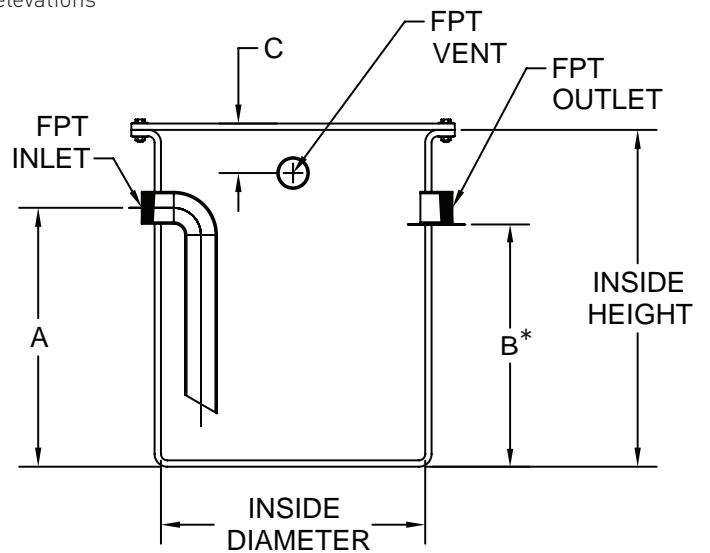

Job Name: \_\_\_\_\_

Job Location: \_\_\_\_\_

Engineer: \_\_\_\_\_

Contractor: \_\_\_\_\_

Representative: \_\_\_\_\_

\*B Dimension listed to calculate actual tank volume (liquid capacity)